

Connection cable

V11-W-15M-PUR-V11-G



- Degree of protection IP68 / IP69
- Resistant to microbes and hydrolysis
- Halogen-free
- Specific design protects against loosening and inaccurate installation

Cordset M12 socket angled to M12 plug straight A-coded, 3-pin, PUR cable grey



Dimensions

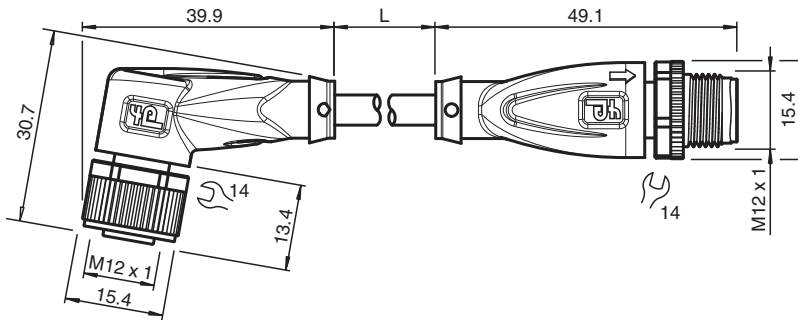

Technical Data

General specifications

| | | | |
|----------------------------------|-------|-------------------------------------|--|
| Connector 1 | | | |
| Connection | | socket | |
| Construction type | | M12 | |
| Style | | angled | |
| Locking | | screw connection | |
| Number of pins | | 3 | |
| Coding | | A-coded | |
| Connector 2 | | | |
| Connection | | plug | |
| Construction type | | M12 | |
| Style | | straight | |
| Locking | | screw connection | |
| Number of pins | | 3 | |
| Coding | | A-coded | |
| Electrical specifications | | | |
| Operating voltage | U_B | max. 250 V AC/DC | |
| Operating current | I_B | max. 4 A | |
| Conformity | | | |
| Degree of protection | | EN 60529 | |
| Plug connection | | connector M12 x 1 : IEC 61076-2-101 | |

Release date: 2023-07-10 Date of issue: 2023-07-10 Filename: 214866_eng.pdf

Refer to "General Notes Relating to Pepperl+Fuchs Product Information".

Pepperl+Fuchs Group
www.pepperl-fuchs.com

USA: +1 330 486 0001
fa-info@us.pepperl-fuchs.com

Germany: +49 621 776 1111
fa-info@de.pepperl-fuchs.com

Singapore: +65 6779 9091
fa-info@sg.pepperl-fuchs.com

PEPPERL+FUCHS

Technical Data

| | | |
|--|---|--|
| Halogen-free | | IEC 60754-1 |
| Ambient conditions | | |
| Ambient temperature | | |
| Plug connector | | -40 ... 90 °C (-40 ... 194 °F) |
| Cable, fixed | | -40 ... 80 °C (-40 ... 176 °F) |
| Cable, flexing | | -25 ... 80 °C (-13 ... 176 °F) |
| Pollution degree | | 3 |
| Mechanical specifications | | |
| Plug connector | | |
| Tightening torque | | 0.6 Nm |
| Loosening protection | | available |
| Tool installation | | straight knurling and hexagon nut SW = 14 mm |
| Mating cycles | | min. 100 |
| Degree of protection | | IP68 / IP69 |
| Cable | | |
| according to IEC/EN 60228 (DIN VDE 0295) class 5 | | |
| Sheath diameter | | 4.8 mm |
| Bending radius | | > 10 x cable diameter, moving > 8 x cable diameter, fixed |
| Sheath stripping force | | max. 10 N / 50 mm |
| Sheath color | | grey (similar to RAL 7001) |
| Number of cores | | 3 |
| Core cross section | | 0.34 mm ² |
| Cores color | | Core 1: brown Core 3: blue Core 4: black |
| Core construction | | 19 x 0.15 mm Ø |
| Length | L | 15 m |
| Cable code | | Li 9Y 11YM 3 x 0.34 |
| Drag chain suitability | | |
| Drag chain cycles | | max. 50 / day |
| Motion velocity | | max. 0.3 m/s |
| Material | | |
| Halogen-free | | yes |
| Plug connector | | |
| Screw connection | | Zinc diecast, nickel-plated |
| Body | | TPU, black |
| Seal | | FKM |
| Contact surface | | gold plated (Au) |
| Flammability | | V-2 |
| Cable | | |
| Sheathing | | PUR based on polyether |
| Core insulation | | PP |
| Chemical resistance | | good |
| Microbial resistance | | yes |
| Hydrolysis resistance | | yes |

Release date: 2023-07-10 Date of issue: 2023-07-10 Filename: 214866_eng.pdf

Refer to "General Notes Relating to Pepperl+Fuchs Product Information".





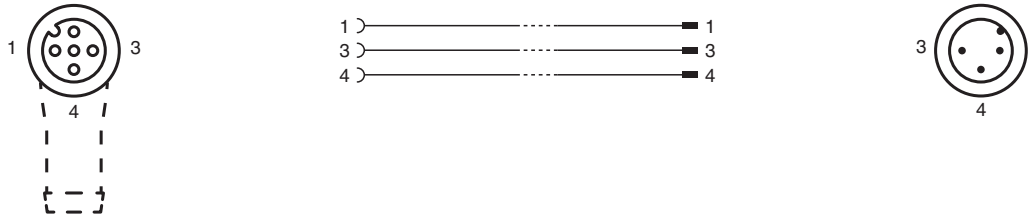

Pepperl+Fuchs Group
www.pepperl-fuchs.comUSA: +1 330 486 0001
fa-info@us.pepperl-fuchs.comGermany: +49 621 776 1111
fa-info@de.pepperl-fuchs.comSingapore: +65 6779 9091
fa-info@sg.pepperl-fuchs.com

PEPPERL+FUCHS

Connection



Accessories

| | | |
|---|------------------------------|--|
|  | MH V1-SCREWDRIVER | Torque screwdriver (0.6 Nm) |
|  | MH V1-BIT M12 | plug-in cap M12 |
|  | V1/V3-LABELHOLDER | Label holder |
|  | V1/V3-LABEL | Label plate |
|  | MH V1-Holder | Modular universal holder for M12 connectors |
|  | V1-CLIP | Unlocking protector for M12 connector |
|  | V1-MARKING-RING-COLOR | Marking rings for M12 connectors, various colors |

Release date: 2023-07-10 Date of issue: 2023-07-10 Filename: 214866_eng.pdf

Refer to "General Notes Relating to Pepperl+Fuchs Product Information".

Pepperl+Fuchs Group
www.pepperl-fuchs.com

USA: +1 330 486 0001
fa-info@us.pepperl-fuchs.com

Germany: +49 621 776 1111
fa-info@de.pepperl-fuchs.com

Singapore: +65 6779 9091
fa-info@sg.pepperl-fuchs.com