



Background suppression sensor ML4.2-8-H-20-IR-4549



- Dual sensor with two Light spots
- Precise background suppression
- Very small black-white difference
- Highly visible LEDs for Power-On, switching status, short-circuit, and undervoltage
- Metal-reinforced fastening holes
- Tamper-proof version with no adjustments
- Push-pull output

Background suppression sensor



Function

The ML100 series is characterized by its miniature housing with integral, all-metal threaded bushings. All versions are equipped with a visible red transmitter LED. This greatly simplifies installation and commissioning. The switching states are easily visible from all directions thanks to the highly visible LEDs.

Dimensions

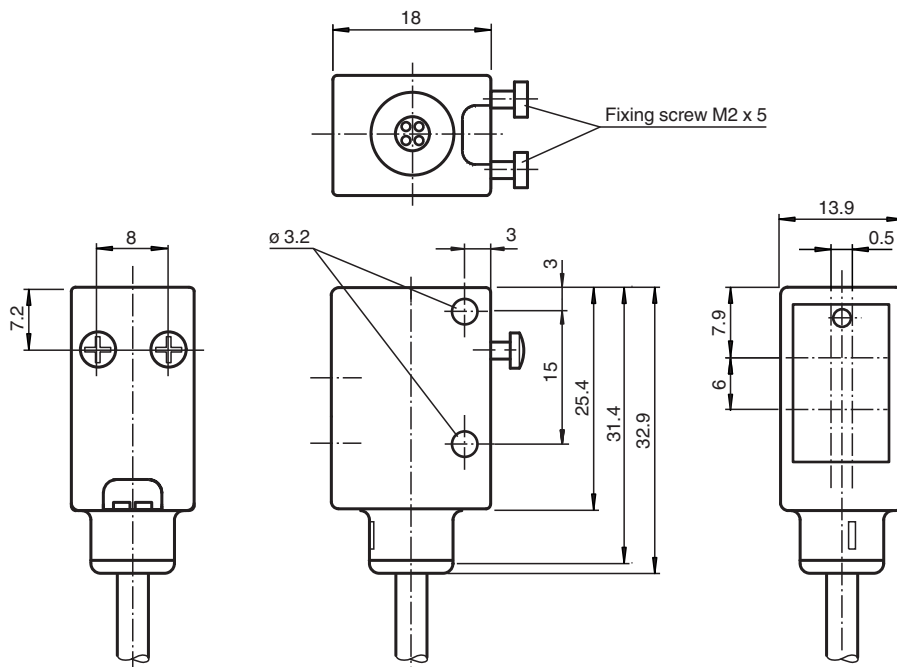

Release date: 2021-09-29 Date of issue: 2021-09-29 Filename: 220405_eng.pdf

Refer to "General Notes Relating to Pepperl+Fuchs Product Information".

Pepperl+Fuchs Group
www.pepperl-fuchs.com

USA: +1 330 486 0001
fa-info@us.pepperl-fuchs.com

Germany: +49 621 776 1111
fa-info@de.pepperl-fuchs.com

Singapore: +65 6779 9091
fa-info@sg.pepperl-fuchs.com

PF PEPPERL+FUCHS

Technical Data

General specifications		
Detection range		7 ... 20 mm
Detection range max.		5 ... 25 mm
Background suppression		starts from 25 mm
Light source		2 IRED
Light type		modulated infrared light , 880 nm
Black-white difference (6 %/90 %)		approx. 1 mm
Diameter of the light spot		2 light spots: size 2.5 mm distance 5 mm at 20 mm
Angle of divergence		approx. 5 °
Ambient light limit		
Continuous light		40000 Lux
Modulated light		5000 Lux
Functional safety related parameters		
MTTF _d		1940 a
Mission Time (T _M)		20 a
Diagnostic Coverage (DC)		0 %
Indicators/operating means		
Operation indicator		LED green, statically lit Power on , Undervoltage indicator: Green LED, pulsing (approx. 0.8 Hz) , short-circuit : LED green flashing (approx. 4 Hz)
Function indicator		LED yellow: lights when object is detected
Electrical specifications		
Operating voltage	U _B	10 ... 30 V DC
Ripple		10 %
No-load supply current	I ₀	< 20 mA
Output		
Switching type		light/dark on electrically switchable
Signal output		Push-pull output, short-circuit protected, reverse polarity protected
Switching voltage		max. 30 V DC
Switching current		max. 100 mA
Voltage drop	U _d	≤ 2.5 V DC
Switching frequency	f	500 Hz
Response time		1 ms
Conformity		
Product standard		EN 60947-5-2
Compliance with standards and directives		
Standard conformity		
Shock and impact resistance		IEC / EN 60068. half-sine, 40 g in each X, Y and Z directions
Vibration resistance		IEC / EN 60068-2-6. Sinus. 10 -150 Hz, 5 g in each X, Y and Z directions
Approvals and certificates		
CE conformity		yes
UL approval		cULus Listed
CCC approval		CCC approval / marking not required for products rated ≤36 V
Ambient conditions		
Ambient temperature		-20 ... 60 °C (-4 ... 140 °F)
Storage temperature		-20 ... 75 °C (-4 ... 167 °F)
Mechanical specifications		
Housing width		13.9 mm
Housing height		31.4 mm
Housing depth		18 mm
Degree of protection		IP67 / IP69K
Connection		2 m fixed cable
Material		

Release date: 2021-09-29 Date of issue: 2021-09-29 Filename: 220405_eng.pdf

Refer to "General Notes Relating to Pepperl+Fuchs Product Information".

 Pepperl+Fuchs Group
 www.pepperl-fuchs.com

 USA: +1 330 486 0001
 fa-info@us.pepperl-fuchs.com

 Germany: +49 621 776 1111
 fa-info@de.pepperl-fuchs.com

 Singapore: +65 6779 9091
 fa-info@sg.pepperl-fuchs.com

PEPPERL+FUCHS

Technical Data

Housing	ABS
Optical face	glass pane
Cable	PUR
Mass	approx. 50 g

Connection Assignment

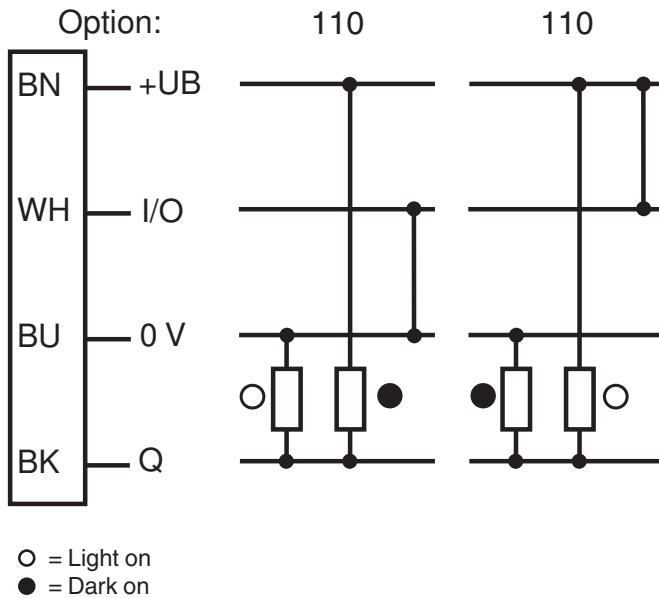

Characteristic Curve

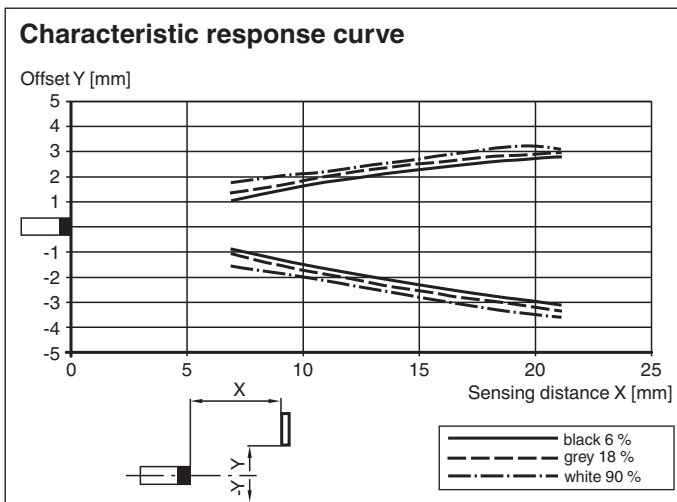

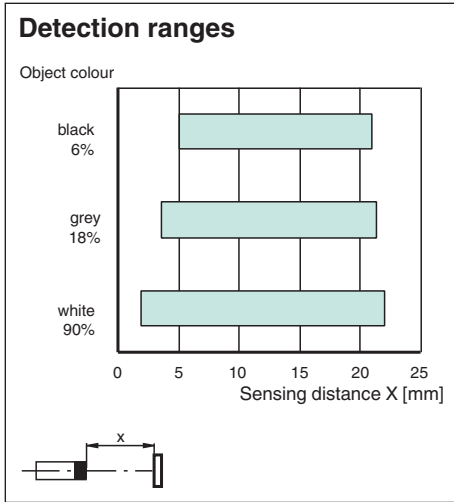

Release date: 2021-09-29 Date of issue: 2021-09-29 Filename: 220405_eng.pdf

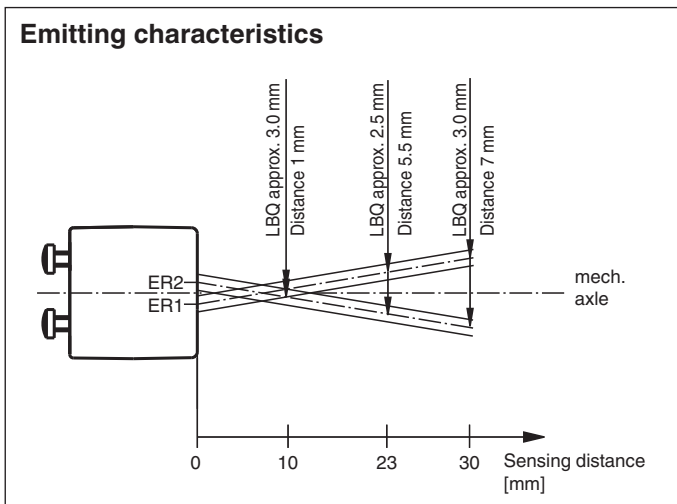
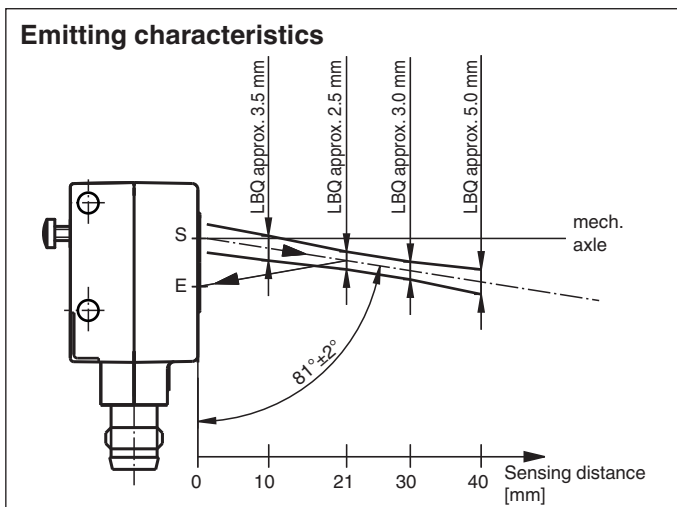

Characteristic Curve







Accessories

	OMH-4.1	Mounting Clamp
	OMH-ML6	Mounting bracket

Release date: 2021-09-29 Date of issue: 2021-09-29 Filename: 220405_eng.pdf

Accessories

	OMH-ML6-U	Mounting bracket
	OMH-ML6-Z	Mounting bracket
	V31-GM-2M-PVC	Female cordset single-ended M8 straight A-coded, 4-pin, PVC cable grey
	V31-WM-2M-PVC	Female cordset single-ended M8 angled A-coded, 4-pin, PVC cable grey