

Inductive sensor NCN3-F31K-N4

- Direct mounting on standard actuators
- Fixed setting
- EC-Type Examination Certificate TÜV99 ATEX 1479X
- Usable up to SIL 2 acc. to IEC 61508

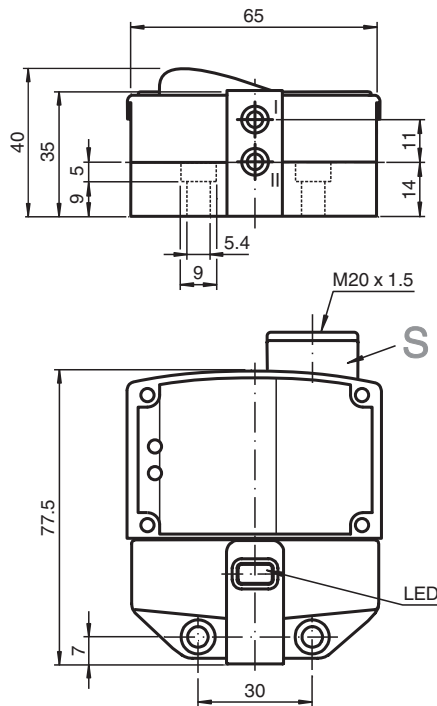

Dimensions



Technical Data

General specifications

Switching function		2 x normally closed (NC)
Output type		NAMUR
Rated operating distance	s_n	3 mm
Installation		flush mountable
Assured operating distance	s_a	0 ... 2.4 mm
Actual operating distance	s_r	2.7 ... 3.3 mm typ.
Actuating element		Stainless steel 1.4305 / AISI 303 8.5 mm x 8.5 mm x 0.5 mm
Reduction factor r_{AI}		0.5
Reduction factor r_{Cu}		0.4

Release date: 2021-03-11 Date of issue: 2021-03-11 Filename: 222679_eng.pdf

Refer to "General Notes Relating to Pepperl+Fuchs Product Information".

Pepperl+Fuchs Group
www.pepperl-fuchs.com

USA: +1 330 486 0001
fa-info@us.pepperl-fuchs.com

Germany: +49 621 776 1111
fa-info@de.pepperl-fuchs.com

Singapore: +65 6779 9091
fa-info@sg.pepperl-fuchs.com

PF PEPPERL+FUCHS

Technical Data

Reduction factor r_{304}		1
Reduction factor r_{317}		1.3
Reduction factor r_{Brass}		0.6
Output type		2-wire
Nominal ratings		
Nominal voltage	U_o	8.2 V (R_i approx. 1 k Ω)
Switching frequency	f	0 ... 3 kHz
Hysteresis	H	typ. 5 %
Reverse polarity protection		reverse polarity protected
Short-circuit protection		yes
Suitable for 2:1 technology		yes , Reverse polarity protection diode not required
Current consumption		
Measuring plate not detected		≥ 3 mA
Measuring plate detected		≤ 1 mA
Time delay before availability	t_v	≤ 1.1 ms
Switching state indicator		LED, yellow
Functional safety related parameters		
Safety Integrity Level (SIL)		SIL 2
MTTF _d		1470 a
Mission Time (T_M)		20 a
Diagnostic Coverage (DC)		0 %
Compliance with standards and directives		
Standard conformity		
NAMUR		EN 60947-5-6:2000 IEC 60947-5-6:1999
Electromagnetic compatibility		NE 21:2007
Standards		EN 60947-5-2:2007 EN 60947-5-2/A1:2012 IEC 60947-5-2:2007 IEC 60947-5-2 AMD 1:2012
Approvals and certificates		
IECEX approval		
Equipment protection level Ga		IECEX TUN 17.0021X
Equipment protection level Gb		IECEX TUN 17.0021X
Equipment protection level Da		IECEX TUN 17.0021X
Equipment protection level Mb		IECEX TUN 17.0021X
ATEX approval		
Equipment protection level Ga		TÜV 99 ATEX 1479 X
Equipment protection level Gb		TÜV 99 ATEX 1479 X
Equipment protection level Gc (ic)		PF13CERT2895 X
Equipment protection level Da		TÜV 99 ATEX 1479 X
EAC conformity		TR CU 020/2011
UL approval		
Ordinary Location		E87056
Hazardous Location		E501628
Control drawing		116-0456
CSA approval		cCSAus Listed, General Purpose
CCC approval		
Hazardous Location		2020322315002262
NEPSI approval		
NEPSI certificate		GYJ19.1410X
Ambient conditions		
Ambient temperature		-25 ... 100 °C (-13 ... 212 °F)
Storage temperature		-40 ... 100 °C (-40 ... 212 °F)

Release date: 2021-03-11 Date of issue: 2021-03-11 Filename: 222679_eng.pdf

Technical Data



Mechanical specifications	
Connection (system side)	Cage tension spring terminals Stripped length 7 mm M20 x 1.5 cable gland usable thread length 11.5 mm screw-in depth max. 11.5 mm
Core cross-section (system side)	Flexible: 0.2 ... 1.5 mm ² rigid: 0.2 ... 2.5 mm ²
Housing material	PBT
Sensing face	PBT
Degree of protection	IP67
Tightening torque, housing screws	1 Nm
Tightening torque, cable gland	M20 x 1.5 ; max. 7 Nm
General information	
Use in the hazardous area	see instruction manuals

Connection

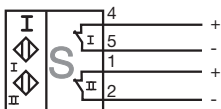



N4



Matching System Components

	BT115A	Activator for F31 series
	BT115X	Activator for F31 series

Accessories

	BT65B	Activator for F31 series
	BT115B	Activator for F31 series
	BT65A	Activator for F31 series
	BT65X	Activator for F31 series

Release date: 2021-03-11 Date of issue: 2021-03-11 Filename: 222679_eng.pdf