

# Strain Gauge Converter

## KFD2-WAC2-Ex1.D

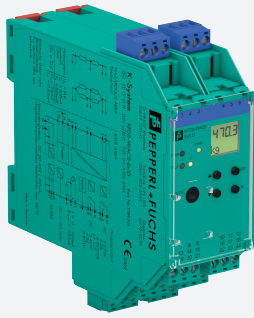

- 1-channel isolated barrier
- 24 V DC supply (Power Rail)
- Strain gauge input (full or half bridge)
- Output 0 mA ... ± 20 mA or 0 V ... ± 10 V
- 2 relay contact outputs
- Programmable high/low alarm
- Configurable by PACTware or keypad
- RS-485 interface
- Line fault detection (LFD)



### Function

This isolated barrier is used for intrinsic safety applications. The device is used with strain gauges, load cells and resistance measuring bridges. Designed to provide 5 V excitation voltage, this barrier's high quality A/D converter allows it to be used with those devices requiring 10 V. Up to four 350 Ω strain gauges connected in parallel may be powered and evaluated. The device is easily configured by the use of keypad or with the PACTware configuration software. The current measurement for tare, zero point, and final value can be entered in this manner. A fault is signaled by LEDs and a separate collective error message output. For additional information, refer to the manual and [www.pepperl-fuchs.com](http://www.pepperl-fuchs.com).

### Application

Single or parallel connection of strain gauges with resulting resistance between 116 Ω to 10 kΩ can be connected and will provide a 4 mA to 20 mA output and 2 relay outputs as well as an RS-485 interface in the non-hazardous area. The device supports the transmission of measured values via the RS-485 interface. In this mode of operation, input signal range may be transmitted with 20 bit resolution with up to 31 signal converters connected to the Power Rail UPR-05 or via terminals 19, 20 and 21. RS-485 communication may be done via the Power Rail when using power feed modules with bus access, e. g. KFD2- EB2.R4A.B or via the terminals 19, 20 and 21 of one module. The device is addressed via keypad and display or with a PC with PACTware and adapter K-ADP-USB. For additional information, refer to the manual and [www.pepperl-fuchs.com](http://www.pepperl-fuchs.com).

### Connection

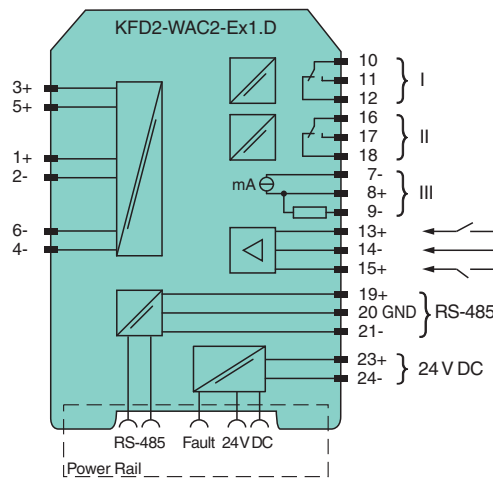
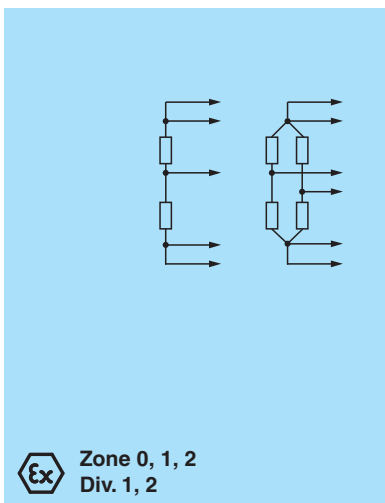

### Technical Data

#### General specifications

Signal type: Analog input

## Technical Data

Supply		
Connection		Power Rail or terminals 23+, 24-
Rated voltage	$U_r$	20 ... 35 V DC
Ripple		within the supply tolerance
Power consumption		max. 3 W
Interface		
Connection		Power Rail or terminals 19+, 20 GND, 21-
Type		RS-485
Programming interface		programming socket
Field circuit		
Connection		terminals 1+, 2-, 3+, 4-, 5+, 6-
Lead resistance		max. 25 $\Omega$ per line
Input I		
Connection		terminals 1+, 2-
Sensor supply		1 ... 5 V
Connection		terminals 3+, 4- (supply); 5+, 6- (signal)
Short-circuit current		50 mA
Load		$\geq 116 \Omega$ up to 5V, $\geq 85 \Omega$ up to 4V
Input		
Connection side		field side
Connection		Input I: terminals 1+, 2-; Input II: terminals 13+, 14-; Input III: terminals 15+, 14-
Programmable Tare		0 ... 500 % of span
Input I		Signal, analog
Input signal		-100 ... 100 mV
Input resistance		> 1 M $\Omega$ for voltage measurement
Input II, III		tare adjustment, calibration and zero
Open circuit voltage/short-circuit current		18 V / 5 mA
Active/Passive		$I > 4 \text{ mA} / I < 1.5 \text{ mA}$
Output		
Connection side		control side
Connection		Output I: terminals 10, 11, 12; Output II: terminals 16, 17, 18; Output III: terminals 7-, 8+, 9-
Output I, II		Relay output
Contact loading		253 V AC/2 A/500 VA/cos $\phi$ min. 0.7; 40 V DC/2 A resistive load
Mechanical life		$2 \times 10^7$ switching cycles
Output III		Analog output
Current range		-20 ... 20 mA
Load		max. 550 $\Omega$
Analog voltage output		0 ... $\pm 10$ V; output resistance 500 $\Omega$ (bridge between terminal 7 and 9)
Analog current output		0 ... $\pm 20$ mA or 4 ... 20 mA; load 0 ... 550 $\Omega$ (terminals 7 and 8)
Line fault detection		downscale -21.5 mA (-10.75 V) or 2 mA (1 V), upscale 21.5 mA (10.75 V)
Collective error message		Power Rail
Transfer characteristics		
Deviation		
Resolution/accuracy		$\leq \pm 0.05$ % incl. non-linearity and hysteresis
Temperature effect		$\leq \pm 0.01$ %/K
Reaction time		300 ... 850 ms
Galvanic isolation		
Input I/other circuits		reinforced insulation according to IEC/EN 61010-1, rated insulation voltage 300 V <sub>eff</sub>
Output I, II against eachother		reinforced insulation according to IEC/EN 61010-1, rated insulation voltage 300 V <sub>eff</sub>
Output I, II/other circuits		reinforced insulation according to IEC/EN 61010-1, rated insulation voltage 300 V <sub>eff</sub>
Output III/Input II, III		not available
Output III/Programming socket		not available

Release date: 2023-05-31 Date of issue: 2023-05-31 Filename: 231221\_eng.pdf

Refer to "General Notes Relating to Pepperl+Fuchs Product Information".

Pepperl+Fuchs Group  
www.pepperl-fuchs.comUSA: +1 330 486 0002  
pa-info@us.pepperl-fuchs.comGermany: +49 621 776 2222  
pa-info@de.pepperl-fuchs.comSingapore: +65 6779 9091  
pa-info@sg.pepperl-fuchs.com

**PEPPERL+FUCHS**

## Technical Data

Other circuits from each other		functional insulation, rated insulation voltage 50 V <sub>eff</sub>
<b>Indicators/settings</b>		
Display elements		LEDs , display
Control elements		Control panel
Configuration		via operating buttons via PACTware
Labeling		space for labeling at the front
<b>Directive conformity</b>		
Electromagnetic compatibility		
Directive 2014/30/EU		EN 61326-1:2013 (industrial locations)
Low voltage		
Directive 2014/35/EU		EN 61010-1:2010
<b>Conformity</b>		
Electromagnetic compatibility		NE 21:2006
Degree of protection		IEC 60529:2001
<b>Ambient conditions</b>		
Ambient temperature		-20 ... 60 °C (-4 ... 140 °F)
<b>Mechanical specifications</b>		
Degree of protection		IP20
Connection		screw terminals
Mass		approx. 250 g
Dimensions		40 x 119 x 115 mm (1.6 x 4.7 x 4.5 inch) (W x H x D) , housing type C2
Mounting		on 35 mm DIN mounting rail acc. to EN 60715:2001
<b>Data for application in connection with hazardous areas</b>		
EU-type examination certificate		TÜV 04 ATEX 2531
Marking		⊕ II (1)G [Ex ia Ga] IIC ⊕ II (1)D [Ex ia Da] IIIC ⊕ I (M1) [Ex ia Ma] I
Supply		Power Rail or terminals 23+, 24- non-intrinsically safe
Maximum safe voltage	U <sub>m</sub>	40 V DC (Attention! U <sub>m</sub> is no rated voltage.)
Input I		terminals 1+, 2- Ex ia IIC, Ex iaD
Voltage U <sub>o</sub>		14 V
Current I <sub>o</sub>		238 mA
Power P <sub>o</sub>		833 mW (linear characteristic)
Input II and III		terminals 13+, 14-; 15+, 14- non-intrinsically safe
Maximum safe voltage	U <sub>m</sub>	40 V DC (Attention! U <sub>m</sub> is no rated voltage.)
Output I, II		terminals 10, 11, 12; 16, 17, 18 non-intrinsically safe
Maximum safe voltage	U <sub>m</sub>	253 V AC / 40 V DC (Attention! U <sub>m</sub> is no rated voltage.)
Contact loading		253 V AC/2 A/500 VA/cos φ min. 0.7; 40 V DC/2 A resistive load
Output III		terminals 7-, 8+, 9- non-intrinsically safe
Maximum safe voltage	U <sub>m</sub>	40 V DC (Attention! U <sub>m</sub> is no rated voltage.)
Interface		RS 485 programming jack
Maximum safe voltage	U <sub>m</sub>	40 V DC (Attention! U <sub>m</sub> is no rated voltage.)
Galvanic isolation		
Input I/other circuits		safe electrical isolation acc. to IEC/EN 60079-11, voltage peak value 375 V
Directive conformity		
Directive 2014/34/EU		EN 60079-0:2012+A11:2013 , EN 60079-11:2012
<b>International approvals</b>		
FM approval		
Control drawing		116-0302 (cFMus)
UL approval		E223772
IECEx approval		
IECEx certificate		IECEx TUN 06.0005
IECEx marking		[Ex ia Ga] IIC , [Ex ia Da] IIIC , [Ex ia Ma] I

Release date: 2023-05-31 Date of issue: 2023-05-31 Filename: 231221\_eng.pdf

Refer to "General Notes Relating to Pepperl+Fuchs Product Information".

Pepperl+Fuchs Group  
www.pepperl-fuchs.comUSA: +1 330 486 0002  
pa-info@us.pepperl-fuchs.comGermany: +49 621 776 2222  
pa-info@de.pepperl-fuchs.comSingapore: +65 6779 9091  
pa-info@sg.pepperl-fuchs.com

**PEPPERL+FUCHS**

**Technical Data**

<b>General information</b>	
Supplementary information	Observe the certificates, declarations of conformity, instruction manuals, and manuals where applicable. For information see <a href="http://www.pepperl-fuchs.com">www.pepperl-fuchs.com</a> .

**Assembly**

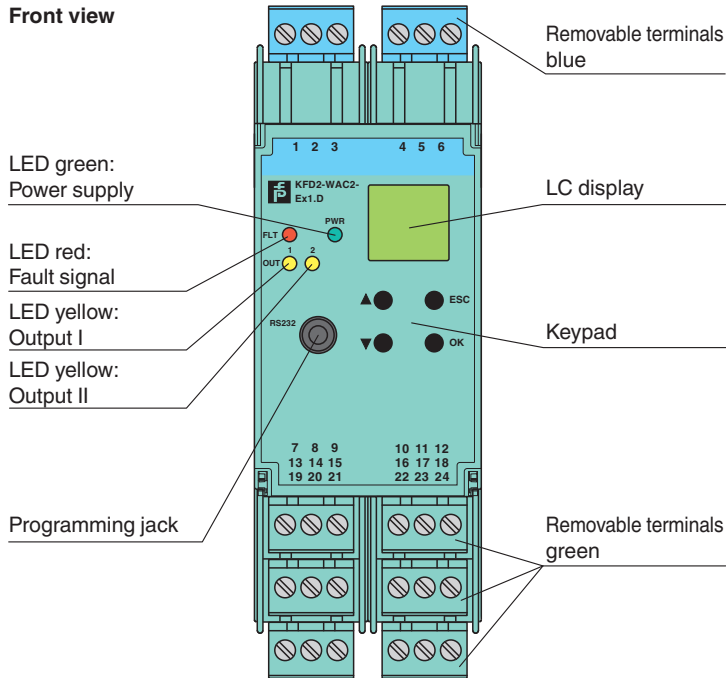



**Matching System Components**

	<b>DTM Interface Technology</b>	Device type manager (DTM) for interface technology
	<b>PACTware 5.0</b>	FDT Framework
	<b>K-ADP-USB</b>	Programming adapter with USB interface
	<b>KFD2-EB2</b>	Power Feed Module
	<b>UPR-03</b>	Universal Power Rail with end caps and cover, 3 conductors, length: 2 m
	<b>UPR-03-M</b>	Universal Power Rail with end caps and cover, 3 conductors, length: 1,6 m
	<b>UPR-03-S</b>	Universal Power Rail with end caps and cover, 3 conductors, length: 0.8 m
	<b>K-DUCT-BU</b>	Profile rail, wiring comb field side, blue
	<b>K-DUCT-BU-UPR-03</b>	Profile rail with UPR-03- * insert, 3 conductors, wiring comb field side, blue

Release date: 2023-05-31 Date of issue: 2023-05-31 Filename: 231221\_eng.pdf

Refer to "General Notes Relating to Pepperl+Fuchs Product Information".

**Accessories**

	<b>KF-ST-5GN</b>	Terminal block for KF modules, 3-pin screw terminal, green
	<b>KF-ST-5BU</b>	Terminal block for KF modules, 3-pin screw terminal, blue
	<b>KF-CP</b>	Red coding pins, packaging unit: 20 x 6