

# Connection cable

## V11-W-BK5M-PVC-U-V11-G



- Degree of protection IP67 / IP68 / IP69
- cURus approval
- Knurled nut suitable for tool assembly
- Immunity to vibration, with mechanical latching

Cordset M12 socket angled to M12 plug straight A-coded, 3-pin, PVC cable black, UL approved



### Dimensions

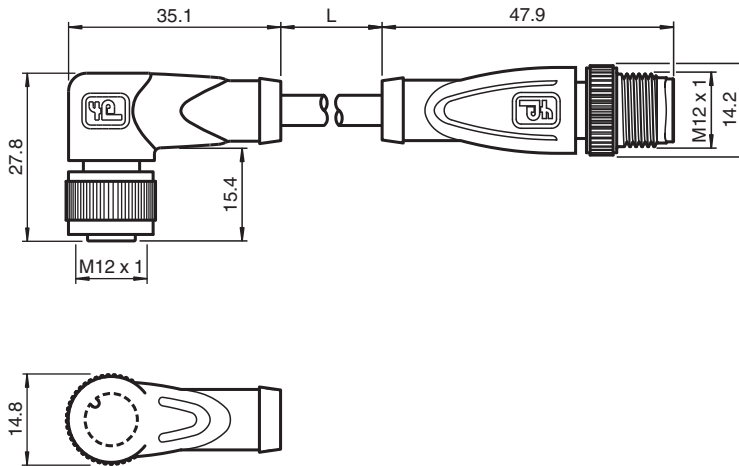

### Technical Data

#### General specifications

<b>Connector 1</b>	
Connection	socket
Construction type	M12
Style	angled
Locking	screw connection
Number of pins	3
Coding	A-coded
<b>Connector 2</b>	
Connection	plug
Construction type	M12
Style	straight
Locking	screw connection
Number of pins	3
Coding	A-coded
UL File Number	E231213

#### Electrical specifications

Release date: 2023-07-10 Date of issue: 2023-07-10 Filename: 240776-0010\_eng.pdf

Refer to "General Notes Relating to Pepperl+Fuchs Product Information".

Pepperl+Fuchs Group  
www.pepperl-fuchs.com

USA: +1 330 486 0001  
fa-info@us.pepperl-fuchs.com

Germany: +49 621 776 1111  
fa-info@de.pepperl-fuchs.com

Singapore: +65 6779 9091  
fa-info@sg.pepperl-fuchs.com

**PEPPERL+FUCHS**

## Technical Data





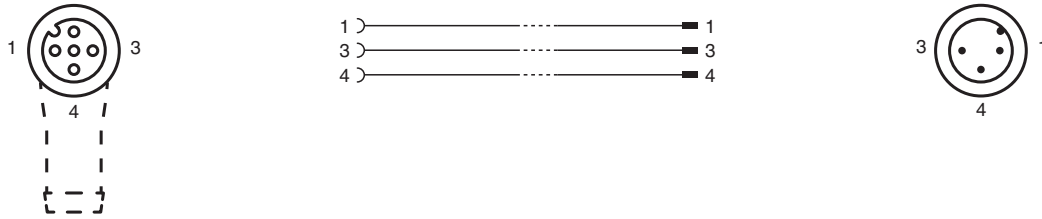

Operating voltage	U <sub>B</sub>	max. 250 V AC/DC
Operating current	I <sub>B</sub>	max. 4 A
<b>Conformity</b>		
Degree of protection		EN 60529
Plug connection		connector M12 x 1 : IEC 61076-2-101
Flammability		UL 1581 , IEC 60332-1-2
<b>Approvals and certificates</b>		
UL approval		AWM STYLE 2095 AWM I/II A/B 80°C 300V FT1 (cable)
<b>Ambient conditions</b>		
Ambient temperature		
Plug connector		-40 ... 90 °C (-40 ... 194 °F)
Cable, fixed		-25 ... 80 °C (-13 ... 176 °F)
Cable, flexing		-5 ... 80 °C (23 ... 176 °F)
Pollution degree		3
<b>Mechanical specifications</b>		
Plug connector		
Tightening torque		0.6 Nm
Loosening protection		available
Tool installation		straight knurling
Mating cycles		min. 100
Degree of protection		IP67 / IP68 / IP69
Cable		according to IEC/EN 60228 (DIN VDE 0295) class 5
Sheath diameter		4.3 mm
Bending radius		> 15 x cable diameter, moving > 5 x cable diameter, fixed
Sheath stripping force		max. 50 N / 300 mm
Sheath color		black (similar to RAL 9005)
Number of cores		3
Core cross section		0.34 mm <sup>2</sup>
Cores color		Core 1: brown Core 3: blue Core 4: black
Core construction		19 x 0.15 mm Ø
Length	L	5 m
Cable code		Li YY 3 x 0,34
<b>Material</b>		
Plug connector		
Screw connection		Zinc diecast, nickel-plated
Body		TPU, black
Contact surface		Au
Flammability		V-2
Cable		
Sheathing		PVC
Core insulation		PVC
Flammability		FT1

Release date: 2023-07-10 Date of issue: 2023-07-10 Filename: 240776-0010\_eng.pdf

## Connection



## Accessories

	<b>MH V1-SCREWDRIVER</b>	Torque screwdriver (0.6 Nm)
	<b>MH V1-BIT M12</b>	plug-in cap M12
	<b>V1/V3-LABELHOLDER</b>	Label holder
	<b>V1/V3-LABEL</b>	Label plate
	<b>MH V1-Holder</b>	Modular universal holder for M12 connectors
	<b>V1-CLIP</b>	Unlocking protector for M12 connector
	<b>V1-MARKING-RING-COLOR</b>	Marking rings for M12 connectors, various colors