

Connection cable

V31-WM-BK2M-PVC-U-V31-GM



- Degree of protection IP68
- UL listed for USA and Canada
- Specific design protects against loosening and inaccurate installation

Cordset M8 socket angled to M8 plug straight A-coded, 4-pin, PVC cable black, UL approved



Dimensions

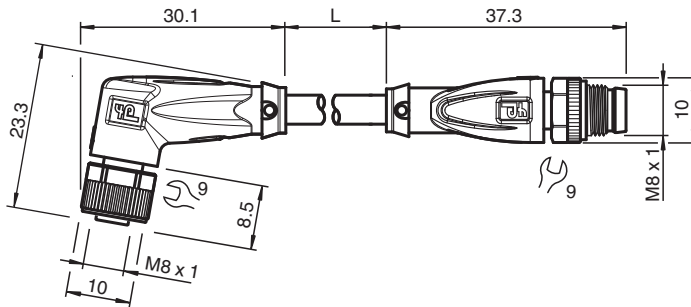

Technical Data

| General specifications | | |
|---------------------------|----------------|------------------|
| Connector 1 | | |
| Connection | | socket |
| Construction type | | M8 |
| Style | | angled |
| Locking | | screw connection |
| Number of pins | | 4 |
| Coding | | A-coded |
| Connector 2 | | |
| Connection | | plug |
| Construction type | | M8 |
| Style | | straight |
| Locking | | screw connection |
| Number of pins | | 4 |
| Coding | | A-coded |
| Electrical specifications | | |
| Operating voltage | U _B | max. 30 V AC/DC |

Release date: 2022-11-30 Date of issue: 2022-12-01 Filename: 240815-0007_eng.pdf

Refer to "General Notes Relating to Pepperl+Fuchs Product Information".

Pepperl+Fuchs Group
www.pepperl-fuchs.com

USA: +1 330 486 0001
fa-info@us.pepperl-fuchs.com

Germany: +49 621 776 1111
fa-info@de.pepperl-fuchs.com

Singapore: +65 6779 9091
fa-info@sg.pepperl-fuchs.com

PF PEPPERL+FUCHS

Technical Data

| | | |
|-----------------------------------|----------------|---|
| Operating current | I _B | max. 3 A |
| Conformity | | |
| Degree of protection | | EN 60529 |
| Plug connection | | connector M8 x 1 : IEC 61076-2-104 |
| Flammability | | UL 1581 , IEC 60332-1-2 |
| Approvals and certificates | | |
| UL approval | | AWM STYLE 2095 AWM I/II A/B 80°C 300V FT1 (cable) |
| UL File Number | | E231213 |
| Ambient conditions | | |
| Ambient temperature | | |
| Plug connector | | -40 ... 90 °C (-40 ... 194 °F) |
| Cable, fixed | | -25 ... 80 °C (-13 ... 176 °F) |
| Cable, flexing | | -5 ... 80 °C (23 ... 176 °F) |
| Pollution degree | | 3 |
| Mechanical specifications | | |
| Plug connector | | |
| Tightening torque | | 0.4 Nm |
| Loosening protection | | available |
| Tool installation | | straight knurling and hexagon nut SW = 9 mm |
| Mating cycles | | min. 100 |
| Degree of protection | | IP68 |
| Cable | | according to IEC/EN 60228 (DIN VDE 0295) class 5 |
| Sheath diameter | | 4.3 mm |
| Bending radius | | > 15 x cable diameter, moving > 5 x cable diameter, fixed |
| Sheath stripping force | | max. 50 N / 300 mm |
| Sheath color | | black (similar to RAL 9005) |
| Number of cores | | 4 |
| Core cross section | | 0.34 mm ² |
| Cores color | | Core 1: brown Core 2: white Core 3: blue Core 4: black |
| Core construction | | 19 x 0.15 mm Ø |
| Length | L | 2 m |
| Cable code | | Li YY 4 x 0,34 |
| Material | | |
| Plug connector | | |
| Screw connection | | Zinc diecast, nickel-plated |
| Body | | TPU, black |
| Seal | | FKM |
| Contact surface | | gold plated (Au) |
| Flammability | | V-2 |
| Cable | | |
| Sheathing | | PVC |
| Core insulation | | PVC |
| Flammability | | FT1 |

Release date: 2022-11-30 Date of issue: 2022-12-01 Filename: 240815-0007_eng.pdf

Refer to "General Notes Relating to Pepperl+Fuchs Product Information".

Pepperl+Fuchs Group
www.pepperl-fuchs.com

USA: +1 330 486 0001
fa-info@us.pepperl-fuchs.com

Germany: +49 621 776 1111
fa-info@de.pepperl-fuchs.com



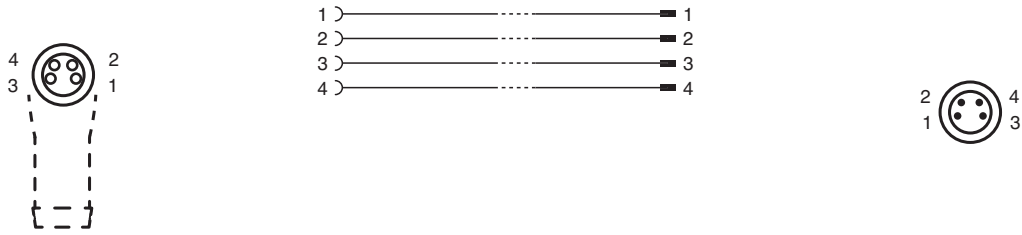

Singapore: +65 6779 9091
fa-info@sg.pepperl-fuchs.com

 PEPPERL+FUCHS

Connection Assignment



Accessories

| | | |
|---|--------------------------|--|
|  | MH V3-SCREWDRIVER | Torque screwdriver (0.4 Nm) |
|  | MH V3-BIT M8 | plug-in cap for M8 |
|  | V1/V3-LABELHOLDER | Label holder |
|  | V1/V3-LABEL | Label plate |
|  | MH V3-Holder | Modular universal holder for M8 connectors |

Release date: 2022-11-30 Date of issue: 2022-12-01 Filename: 240815-0007_eng.pdf