

Accessories

DoorScan Profile L3000 5pcs



- Aluminum profile for DoorScan Series
- Length 3000 mm
- for DoorScan design with great profil length

Housing profile DoorScan

Dimensions

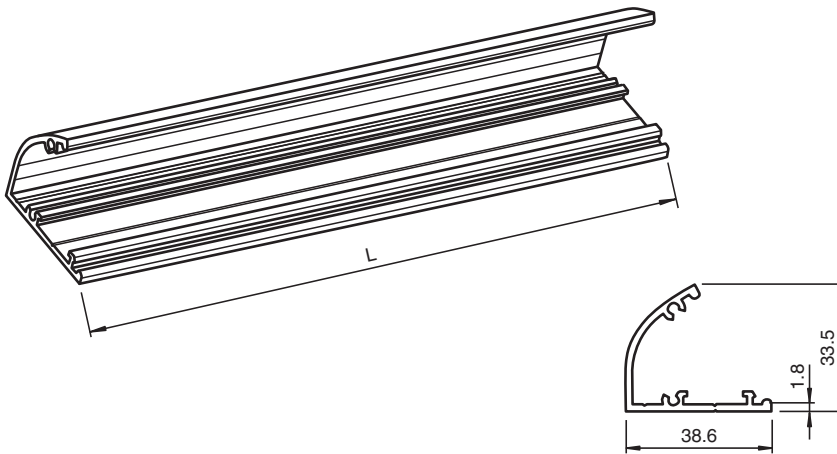

Technical Data

Ambient conditions

Ambient temperature -30 ... 60 °C (-22 ... 140 °F)

Mechanical specifications



Housing length L 3000 mm

Material aluminum

Suitable series

Series DoorScan®, TopScan-S

Accessories

	DoorScan Weather Cap L1200	All-weather hood for DoorScan® and TopScan series sensing strips
	DoorScan Transfer Loop	Door transition cable to door controller for DoorScan® sensor, including cable sheathing and strain relief
	DoorScan Connection Cable 5p	Connecting cable with 5 plug-in connections for DoorScan®-I/-T/-R modules

Release date: 2020-03-24 Date of issue: 2020-10-08 Filename: 251780_eng.pdf

Refer to "General Notes Relating to Pepperl+Fuchs Product Information".

Pepperl+Fuchs Group
www.pepperl-fuchs.com







USA: +1 330 486 0001
fa-info@us.pepperl-fuchs.com

Germany: +49 621 776 1111
fa-info@de.pepperl-fuchs.com

Singapore: +65 6779 9091
fa-info@sg.pepperl-fuchs.com

 **PEPPERL+FUCHS**

Accessories

	DoorScan Cable BS/BGS	Connecting cable for transition from hinge side to leading edge side
	DoorScan End Caps	End cap set for DoorScan® sensor profile
	TopScan-S Profile L1400	Housing profile TopScan-S
	TopScan-S Cover L1400	Housing cover TopScan-S
	DoorScan Relay Module	Replacement/extension sensor module for installation in the DoorScan® and TopScan sensor profile, multifunction interface module
	DoorScan Adapter	Adapter module for installation in the DoorScan® and TopScan sensor profile, multifunction interface module