

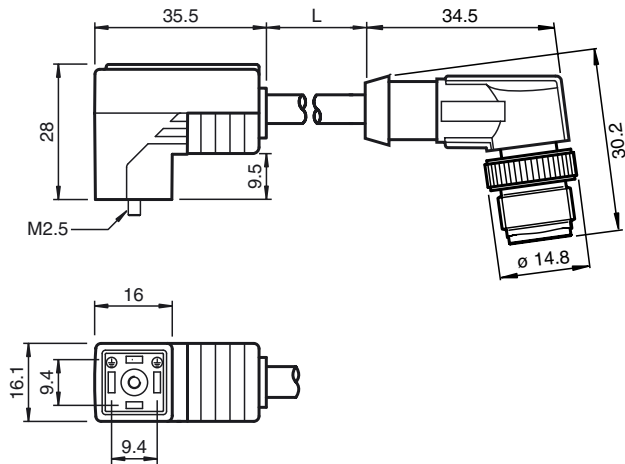

**Dimensions**



**Model Number**

**VMCI-2+P/Z2-0,6M-PVC-V1-W**

Valve connector, Form C (Ind) on M12, 2+PE, LED, Z diode, PVC cable

**Features**

- Valve connector according EN 175301-803 A/ISO 4400 (previously DIN 43650)
- Suitable for F31K and F31K2 double sensors
- Z diode as a protective circuit
- Built-in LED, as operating and function indicator
- Moulded seal
- freely selectable cable models due to bridged protective earth
- Flame resistant cable

**Technical data**

**General specifications**

Number of pins 2 + PE

**Indicators/operating means**

LED yellow Functional display

**Electrical specifications**

Operating voltage  $U_B$  24 V AC/DC  
 Operating current  $I_B$  max. 4 A  
 Volume resistance < 5 m $\Omega$   
 Suppression Zener diode

**Ambient conditions**

Ambient temperature Body: -20 ... 85 °C (-4 ... 185 °F)  
 cable, flexing: -5 ... 80 °C (23 ... 176 °F)  
 cable, fixed: -40 ... 80 °C (-40 ... 176 °F)  
 Pollution Degree 3

**Mechanical specifications**

Degree of protection IP65/IP67  
 Connection Valve connector, Form C (Ind)  
 Material  
 Contacts CuSn  
 Contact surface Sn  
 Body TPU, black  
 Cable PVC  
 Core insulation PVC  
 Cable  
 Sheath diameter  $\varnothing$  4.8 mm  
 Bending radius > 5 x cable diameter, moving  
 > 10 x cable diameter, fixed  
 Color black  
 Cores 3 x 0.5 mm<sup>2</sup>, 20 AWG  
 Conductor construction 28 x 0.15 mm  $\varnothing$   
 Length L 0.6 m

**Electrical connection**

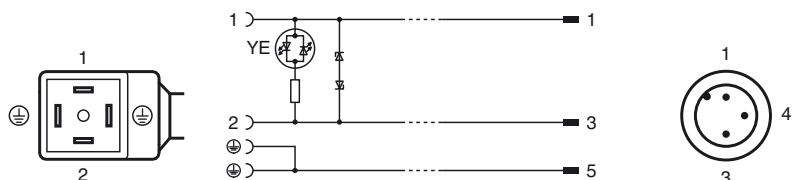

Release date: 2015-12-15 14:51 Date of issue: 2015-12-16 254109\_eng.xml

Refer to "General Notes Relating to Pepperl+Fuchs Product Information".

Pepperl+Fuchs Group  
 www.pepperl-fuchs.com

USA: +1 330 486 0001  
 fa-info@us.pepperl-fuchs.com

Germany: +49 621 776 4411  
 fa-info@de.pepperl-fuchs.com

Singapore: +65 6779 9091  
 fa-info@sg.pepperl-fuchs.com