



Ovládací prvek

BT115X

- Vhodné pro pohony s otáčením směrem vpravo a vlevo
- Směr působení obrácený (koncová poloha netlumená)

Ovládací prvek pro konstrukční řadu F31

Rozměry

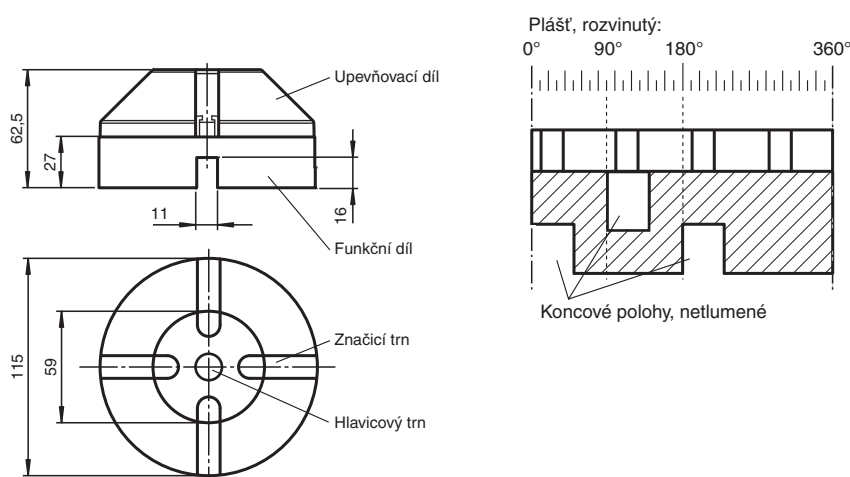

Technické údaje

Všeobecné specifikace

Průměr kroužku	max. 110 mm
Výška rozpěrného pojistného kroužku	max. 7 mm

Okolní podmínky

Okolní teplota	-25 ... 70 °C (-13 ... 158 °F)
----------------	--------------------------------

Mechanické specifikace

Průměr hřídele	< 90 mm
Výška hřídele	30 mm a 50 mm
Šablona upevňovacích otvorů	30 x 130 mm

Materiál

Kryt/skříň	Zpevňovací díl: PA
Distanční podložka	Polyamid (2 ks, tloušťka 10 mm)
Kloboučková ucpávka	PE (1 ks, černá)
Označovací ucpávka	Polyamid (2 ks, žlutá, 2 ks, černá)
Upevňovací šroub	pro ovládací prvky: 1.4305 / AISI 303 (1 ks M6 x 25) pro snímače -F31: 1.4305 / AISI 303 (2 ks M5 x 16, (2 ks M5 x 12)
Ovládací pásek	ušlechtilá ocel 1.4305 / AISI 303 (integrováný)

Datum publikace: 2020-06-30 Datum vydání: 2020-06-30 : 259055_cze.pdf

Viz část Všeobecné poznámky týkající se produktů společnosti Pepperl+Fuchs.

Pepperl+Fuchs Group
www.pepperl-fuchs.com

USA: +1 330 486 0001
fa-info@us.pepperl-fuchs.com

Německo: +49 621 776 1111
fa-info@de.pepperl-fuchs.com

Singapur: +65 6779 9091
fa-info@sg.pepperl-fuchs.com





















PF PEPPERL+FUCHS

Technické údaje

Rozměry

140 g

Vhodné součásti systému

	NBN3-F31-E8-K
	NBN3-F31-E8-K-K
	NBN3-F31-E8-V1
	NBN3-F31-E8-V1-FESTO
	NBN3-F31-E8-V1-Y7011-3680
	NBN3-F31-E8-V16-V15
	NBN3-F31-E8-V18
	NBN3-F31K-E8
	NBN3-F31K-E8-K-FESTO
	NBN3-F31K-E8-K
	NBN3-F31K-E8-V1-V1
	NBN3-F31K-Z8
	NBN3-F31K-Z8-K-FESTO
	NBN3-F31K-Z8-V1-V1
	NBN3-F31K2-E8-B13-S
	NBN3-F31K2-E8-B33-S
	NBN3-F31K2-E8-B43-S
	NBN3-F31K2M-E8-B13-S
	NBN3-F31K2M-E8-B23-S
	NBN3-F31K2M-E8-B33-S
	NBN3-F31K2M-Z8L-B43-S





















Datum publikace: 2020-06-30 Datum vydání: 2020-06-30 : 259055_cze.pdf

Viz část Všeobecné poznámky týkající se produktů společnosti Pepperl+Fuchs.

Pepperl+Fuchs Group
www.pepperl-fuchs.comUSA: +1 330 486 0001
fa-info@us.pepperl-fuchs.comNěmecko: +49 621 776 1111
fa-info@de.pepperl-fuchs.comSingapur: +65 6779 9091
fa-info@sg.pepperl-fuchs.com

PEPPERL+FUCHS

Vhodné součásti systému

	NBN3-F31K2M-E8-B43-S	
	NBN3-F31K2M-Z8L-B13-S	
	NCN3-F31K2M-N4-B23-S	
	NBN3-F31K2M-Z8L-B23-S	
	NBN3-F31K2M-Z8L-B33-S	
	NBN3-F31K2-Z8L-B13-S-Y292890	
	NBN3-F31K2-Z8L-B13-S	
	NBN3-F31K2-Z8L-B13-S-Y300073	
	NBN3-F31K2-Z8L-B33-S	
	NBN3-F31-U8-K	
	NBN3-F31-U8-V18	
	NBN3-F31-Z8-K	
	NBN3-F31-Z8-K-K	
	NBN3-F31-Z8-V1-FESTO	
	NBN3-F31-Z8-V18	
	NCN3-F31-B3B-V1	Zpětný hlásič polohy ventilů a stavební prvek ovládacího řízení ventilů
	NCN3-F31-B3B-V1-K	Zpětný hlásič polohy ventilů a stavební prvek ovládacího řízení ventilů
	NCN3-F31-B3B-V1-V1	Zpětný hlásič polohy ventilů a stavební prvek ovládacího řízení ventilů
	NCN3-F31-B3B-V1-V1-FESTO	Zpětný hlásič polohy ventilů a stavební prvek ovládacího řízení ventilů
	NCN3-F31-B3-V1-K	Zpětný hlásič polohy ventilů a stavební prvek ovládacího řízení ventilů
	NCN3-F31K-B3B-B31	Zpětný hlásič polohy ventilů a stavební prvek ovládacího řízení ventilů





















Datum publikace: 2020-06-30 Datum vydání: 2020-06-30 : 259055_cze.pdf

Viz část Všeobecné poznámky týkající se produktů společnosti Pepperl+Fuchs.

Pepperl+Fuchs Group
www.pepperl-fuchs.comUSA: +1 330 486 0001
fa-info@us.pepperl-fuchs.comNěmecko: +49 621 776 1111
fa-info@de.pepperl-fuchs.comSingapur: +65 6779 9091
fa-info@sg.pepperl-fuchs.com

PEPPERL+FUCHS

Vhodné součásti systému



	NCN3-F31K-N4	
	NCN3-F31K2-N5-B33-S	
	NCN3-F31K-N4-B13	
	NCN3-F31K2M-N4-B13-S	
	NCN3-F31K2-N4-B33-S	
	NCN3-F31K2-N5-B13-S	
	NCN3-F31K2-N4-B13-S	
	NCN3-F31K-N4-B13-S	
	NCN3-F31K-N4-K-FESTO	
	NCN3-F31K-N4-K	
	NCN3-F31K-N4-K-S	
	NCN3-F31K-N4-S	
	NCN3-F31K-N4-V1-V1	
	NCN3-F31K-N5-K	
	NCN3-F31-N4-K	
	NCN3-F31-N4-K-K	
	NCN3-F31-N4-V1-FESTO	
	NCN3-F31-N4-V1	
	NCN3-F31-N4-V16-K	
	NCN3-F31-N4-V16-V16	
	NCN3-F31-N4-V18	
	NBN3-F31K2M-E8-B13-S-3G-3D	

Datum publikace: 2020-06-30 Datum vydání: 2020-06-30 : 259055_cze.pdf

Viz část Všeobecné poznámky týkající se produktů společnosti Pepperl+Fuchs.

Pepperl+Fuchs Group
www.pepperl-fuchs.comUSA: +1 330 486 0001
fa-info@us.pepperl-fuchs.comNěmecko: +49 621 776 1111
fa-info@de.pepperl-fuchs.comSingapur: +65 6779 9091
fa-info@sg.pepperl-fuchs.com PEPPERL+FUCHS

Vhodné součásti systému

	NBN3-F31K2M-Z8L- B13-S-3G-3D	
	NBN3-F31K2M-Z8L- B13-S-3G-3D-Y	
	NBN3-F31K2M-Z8L- B13-S-3G-3D-Y	

Funkce

Aktivátor je vyroben z nerezové oceli a vodivého plastu, který brání vzniku statického náboje a umožňuje instalaci v potenciálně výbušných prostředích.