

Termination Board

HiDTB08-SCT-44C-SC-RA

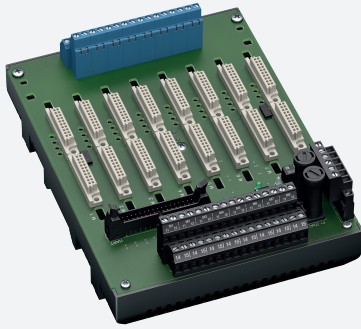

- For 8 modules
- 24 V DC supply
- Supported signal types: DI/DO/AI/TI/AO
- Hazardous area: screw terminals, blue
- Non-hazardous area: screw terminals, black



Function

The termination board has 8 plug-in slots for isolators. Any isolator can be inserted into any slot, enabling a mixture of I/O types on one termination board. The termination board features fixed screw terminals for the field side connection and for the control side connection along with a HART cordset for interconnection to a separate HART Communication Board. Information about missing supply voltage of the isolators is available for the system as volt-free contact at the redundant power supply terminals. Wiring errors from field side will be reported via the same relay contact, if this function supported by the the isolators. The termination board is supplied with a robust plastic housing as standard. This design permits the fast and reliable installation on 35 mm DIN mounting rail acc. to EN 60715 in the cabinet.

Connection

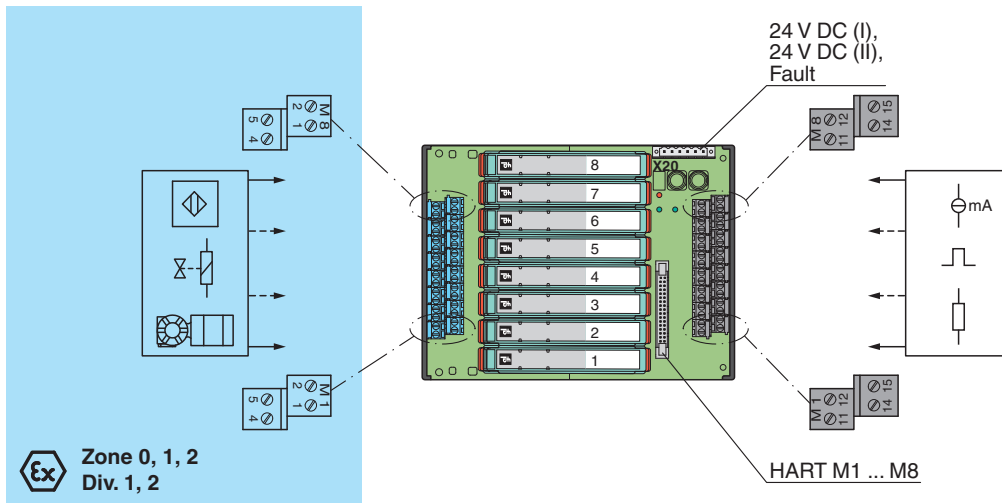

Technical Data

Supply	
Connection	X20: terminals 3, 5(+); 4, 6(-)
Nominal voltage	24 V DC , in consideration of rated voltage of used isolators
Voltage drop	0.9 V , voltage drop across the series diode on the termination board must be considered
Ripple	≤ 10 %
Fusing	2 A , in each case for 8 modules
Power dissipation	≤ 500 mW , without modules
Reverse polarity protection	yes
Redundancy	

Release date: 2023-02-20 Date of issue: 2023-02-20 Filename: 260222_eng.pdf

Refer to "General Notes Relating to Pepperl+Fuchs Product Information".

Pepperl+Fuchs Group
www.pepperl-fuchs.com

USA: +1 330 486 0002
pa-info@us.pepperl-fuchs.com

Germany: +49 621 776 2222
pa-info@de.pepperl-fuchs.com

Singapore: +65 6779 9091
pa-info@sg.pepperl-fuchs.com

PEPPERL+FUCHS

Technical Data

Supply	Redundancy available. The supply for the isolators is decoupled, monitored and fused.
Fault indication output	
Connection	X20: terminals 1, 2
Output type	volt-free contact
Switch behaviour	no fault: relay contact closed power supply fault: relay contact open module fault: relay contact open
Contact loading	30 V DC, 1 A
Indicators/settings	
Display elements	LED PWR1 (termination board power supply), green LED LED PWR2 (termination board power supply), green LED LED FAULT (fault indication), red LED - LED lits: module fault - LED flashes: power supply fault
Directive conformity	
Electromagnetic compatibility	
Directive 2014/30/EU	EN 61326-1:2013 (industrial locations)
Conformity	
Electromagnetic compatibility	NE 21:2017 For further information see system description.
Degree of protection	IEC 60529:2001
Ambient conditions	
Ambient temperature	-20 ... 60 °C (-4 ... 140 °F)
Storage temperature	-40 ... 70 °C (-40 ... 158 °F)
Mechanical specifications	
Degree of protection	IP20
Connection	
Field side	explosion hazardous area: 4 screw terminals per module , blue
Control side	non-explosion hazardous area: 4 screw terminals per module , black
Supply	pluggable screw terminals , black
Fault output	pluggable screw terminals , black
Core cross section	screw terminals: 0.25 ... 1.5 mm ² (24 ... 12 AWG)
Material	housing: polycarbonate, 10 % glass fiber reinforced
Mass	approx. 510 g
Dimensions	150 x 200 x 163 mm (5.9 x 7.9 x 6.42 inch) (W x H x D) , depth including module assembly
Mounting	on 35 mm DIN mounting rail acc. to EN 60715:2001
Data for application in connection with hazardous areas	
EU-type examination certificate	CESI 11 ATEX 062
Marking	⊕ II (1)G [Ex ia Ga] IIC ⊕ II (1)D [Ex ia Da] IIIC ⊕ I (M1) [Ex ia Ma] I
Non-hazardous area	
Maximum safe voltage	250 V (Attention! U _m is no rated voltage.)
Galvanic isolation	
Field circuit/control circuit	safe electrical isolation acc. to IEC/EN 60079-11, voltage peak value 375 V
Directive conformity	
Directive 2014/34/EU	EN IEC 60079-0:2018+AC:2020 , EN 60079-11:2012 , EN 50303:2000
International approvals	
CSA approval	
Control drawing	see control drawing of corresponding modules
IECEx approval	
IECEx certificate	IECEx CES 11.0022
IECEx marking	[Ex ia Ga] IIC [Ex ia Da] IIIC [Ex ia Ma] I
General information	

Release date: 2023-02-20 Date of issue: 2023-02-20 Filename: 260222_eng.pdf

Refer to "General Notes Relating to Pepperl+Fuchs Product Information".









Pepperl+Fuchs Group
www.pepperl-fuchs.comUSA: +1 330 486 0002
pa-info@us.pepperl-fuchs.comGermany: +49 621 776 2222
pa-info@de.pepperl-fuchs.comSingapore: +65 6779 9091
pa-info@sg.pepperl-fuchs.com
 PEPPERL+FUCHS

Technical Data

Supplementary information

Observe the certificates, declarations of conformity, instruction manuals, and manuals where applicable. For information see www.pepperl-fuchs.com.

Accessories

	HiATB01-HART-2X16	HART Communication Board
	HiDMux2700	HART Multiplexer Master
	H-CJC-SC-8	Resistance thermometer for cold junction compensation for H-System termination boards
	HiACA-UNI-FLK34-FLK34-0M5	HART Connection Cable, length: 0,5 m
	HiACA-UNI-FLK34-FLK34-1M0	HART Connection Cable, length: 1 m
	HiACA-UNI-FLK34-FLK34-2M0	HART Connection Cable, length: 2 m
	HiACA-UNI-FLK34-FLK34-3M0	HART Connection Cable, length: 3 m
	HiACA-UNI-FLK34-FLK34-6M0	HART Connection Cable, length: 6 m
	HiALC-HIDTB-SET-150	Label carrier for HiD termination boards

Connection

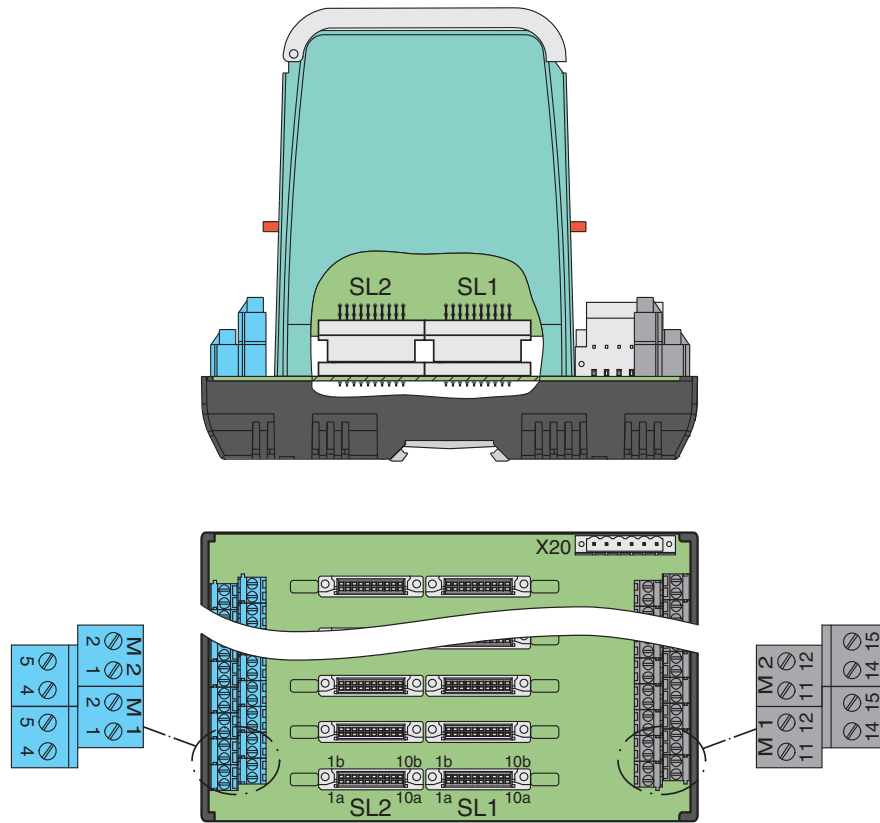

Insert the isolated barrier on the Termination Board. This closes the signal circuit between field side and control side. Connect field devices and controller to the terminals or connecting plugs of the Termination Board. For pin assignment between terminals, connecting plugs and connectors SL1/SL2, see drawing "Connection diagram" or the corresponding pin-out table on www.pepperl-fuchs.com.



For exact pin assignment for fieldside and control side, see the documentation of the isolated barrier.

Application

Typical loop

Release date: 2023-02-20 Date of issue: 2023-02-20 Filename: 260222_eng.pdf

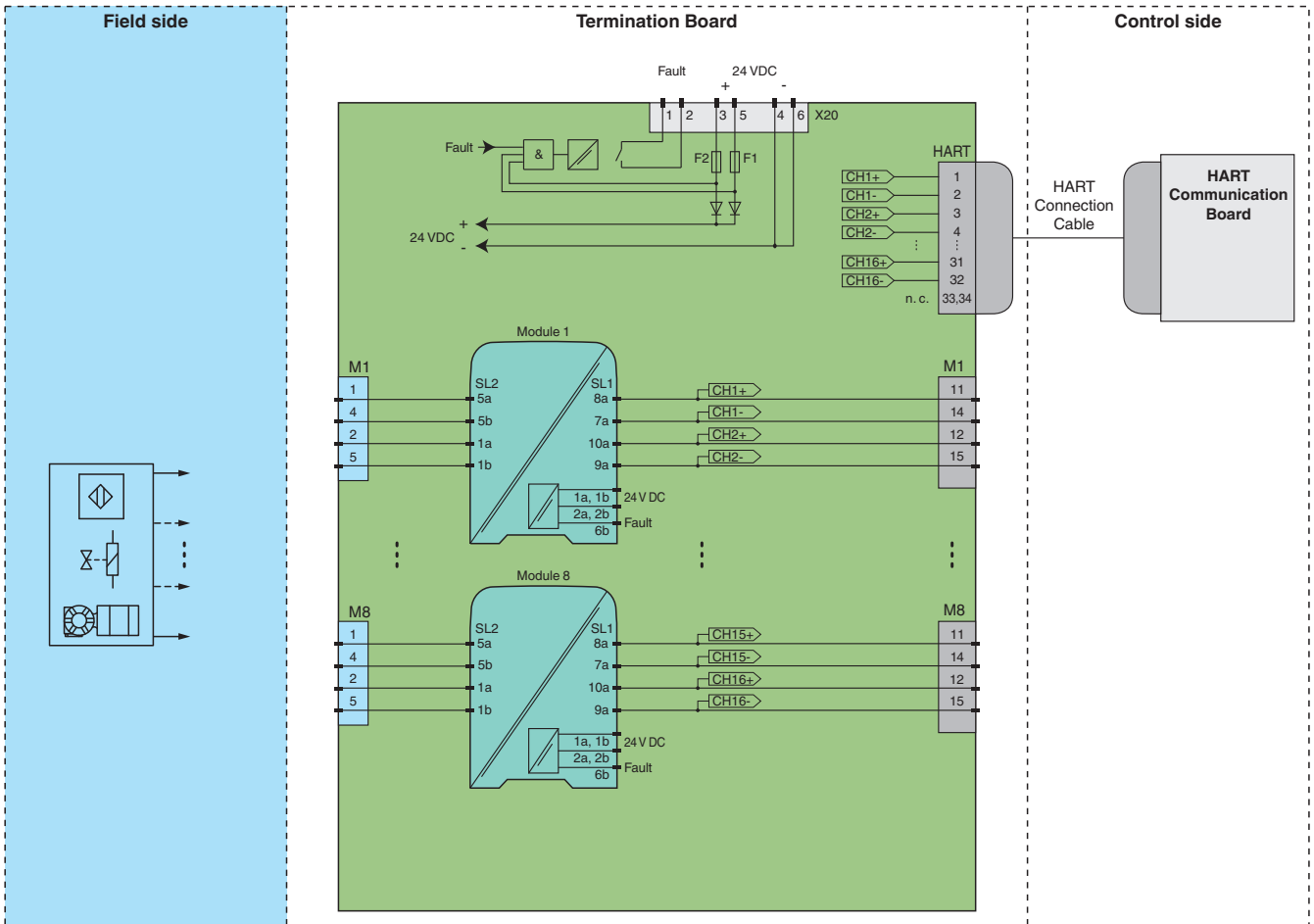

For exact pin assignment for connection to field side and control side, see the documentation of the isolated barrier.



The pin-out configuration has to be observed. For information see corresponding pin-out table on www.pepperl-fuchs.com.