



Ultrasonic sensor UC400-F77-EP-IO-V31

- IO-Link interface for service and process data
- Programmable via DTM with PACTWARE
- Continuous distance value via IO-Link process data
- Selectable sound lobe width
- Synchronization options
- Temperature compensation
- Push-pull output

Single head system



Dimensions

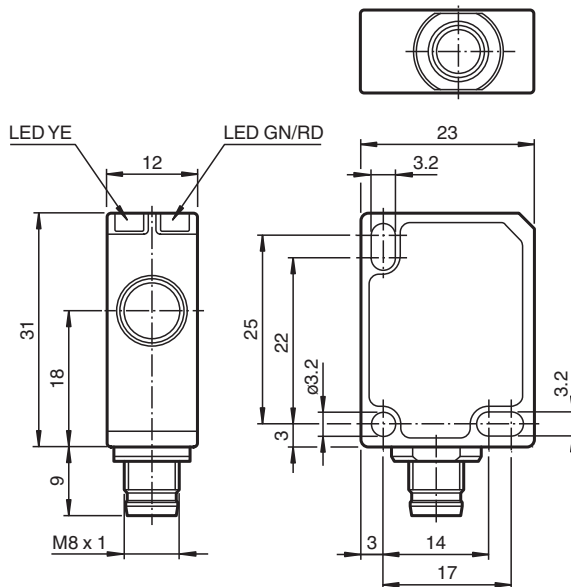

Technical Data

General specifications

Sensing range	30 ... 400 mm
Adjustment range	40 ... 400 mm
Dead band	0 ... 30 mm
Standard target plate	20 mm x 20 mm
Transducer frequency	approx. 310 kHz
Response delay	minimum : 10 ms factory setting: 37 ms
Sensor cycle time	≥ 10 ms (factory setting) ; programmable to 60 s

Memory

Release date: 2022-12-05 Date of issue: 2022-12-05 Filename: 261243_eng.pdf

Refer to "General Notes Relating to Pepperl+Fuchs Product Information".

Pepperl+Fuchs Group
www.pepperl-fuchs.com

USA: +1 330 486 0001
fa-info@us.pepperl-fuchs.com

Germany: +49 621 776 1111
fa-info@de.pepperl-fuchs.com

Singapore: +65 6779 9091
fa-info@sg.pepperl-fuchs.com

PF PEPPERL+FUCHS

Technical Data

Non-volatile memory	EEPROM	
Write cycles	300000	
Indicators/operating means		
LED green	solid: power on flashing: standby mode or IO-Link communication	
LED yellow	solid: object in evaluation range flashing: switch point programming, object detected	
LED red	solid: error flashing: switch point programming, object not detected	
Electrical specifications		
Operating voltage	U_B	10 ... 30 V DC , ripple 10 % _{SS}
No-load supply current	I_0	≤ 40 mA
Power consumption	P_0	≤ 400 mW
Time delay before availability	t_v	≤ 300 ms
Interface		
Interface type	IO-Link (via C/Q = Pin 4)	
IO-Link revision	1.1	
Device profile	Smart Sensor	
Device ID	0x300301 (3146497)	
Transfer rate	COM2 (38.4 kBit/s)	
Min. cycle time	2.3 ms	
Process data width	16 bit	
SIO mode support	yes	
Compatible master port type	A	
Input/Output		
Input/output type	1 synchronization connection, bidirectional	
0 Level	0 ... 1 V	
1 Level	2.5 V ... U_B	
Input impedance	> 22 k Ω	
Output rated operating current	current source < 2.5 mA	
Pulse length	≥ 1 ms with external control, low active	
Synchronization frequency		
Common mode operation	≤ 109 Hz	
Multiplex operation	≤ 109 Hz / n , n = number of sensors , n ≤ 10	
Output		
Output type	1 push-pull (4 in 1) output, short-circuit protected, reverse polarity protected	
Rated operating current	I_e	100 mA , short-circuit/overload protected
Voltage drop	U_d	≤ 2.5 V
Repeat accuracy	≤ ± 0.1 % of full-scale value	
Switching frequency	f	factory setting: 16 Hz programmable max. 35 Hz
Range hysteresis	H	1 % of the adjusted operating range (default settings), programmable , min. 1 mm
Temperature influence	≤ ± 0.75 % of the end value (with temperature compensation) from 10 minutes after switching on the sensor ; 0.17 %/K (without temperature compensation)	
Compliance with standards and directives		
Standard conformity		
Standards	EN IEC 60947-5-2:2020 IEC 60947-5-2:2019 IEC 61131-9:2013	
Approvals and certificates		
UL approval	cULus Listed, Class 2 Power Source	
CCC approval	CCC approval / marking not required for products rated ≤36 V	
Ambient conditions		
Ambient temperature	-25 ... 70 °C (-13 ... 158 °F)	
Storage temperature	-40 ... 85 °C (-40 ... 185 °F)	
Mechanical specifications		

Release date: 2022-12-05 Date of issue: 2022-12-05 Filename: 261243_eng.pdf

Refer to "General Notes Relating to Pepperl+Fuchs Product Information".

Pepperl+Fuchs Group
www.pepperl-fuchs.comUSA: +1 330 486 0001
fa-info@us.pepperl-fuchs.comGermany: +49 621 776 1111
fa-info@de.pepperl-fuchs.comSingapore: +65 6779 9091
fa-info@sg.pepperl-fuchs.com

PEPPERL+FUCHS

Technical Data

Connection type	Connector plug M8 x 1 , 4-pin
Degree of protection	IP67
Material	
Housing	Polycarbonate
Transducer	epoxy resin/hollow glass sphere mixture; polyurethane foam
Installation position	any position
Mass	9 g
Tightening torque, fastening screws	max. 0.2 Nm
Factory settings	
Output	near switch point: 40 mm far switch point: 400 mm Output mode: Window mode Output logic: normally open
Beam width	wide

Connection

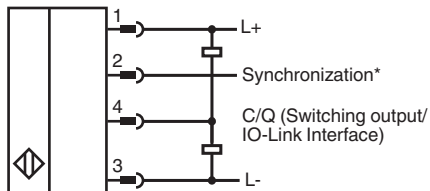

*if not used connect to ground (0V)

Connection Assignment



Wire colors in accordance with EN 60947-5-2

1	BN	(brown)
2	WH	(white)
3	BU	(blue)
4	BK	(black)

Release date: 2022-12-05 Date of issue: 2022-12-05 Filename: 261243_eng.pdf

Characteristic Curve

Characteristic response curve

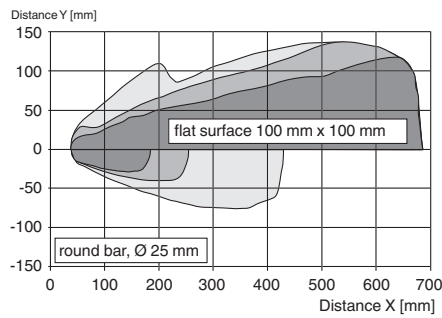

Switching output modes

1. Switch point mode

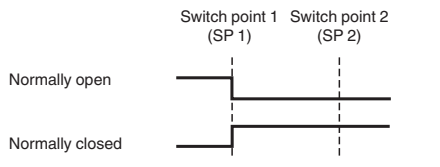

2. Window mode

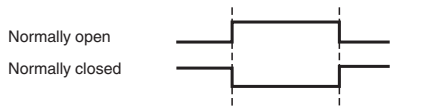



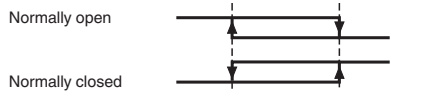

3. Hysteresis mode

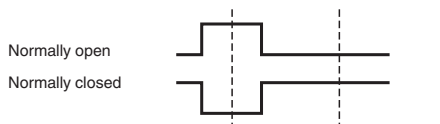

4. Retroreflective mode











Accessories

	V31-GM-2M-PVC	Female cordset single-ended M8 straight A-coded, 4-pin, PVC cable grey
	V31-GM-1M-PVC-V1-G	Cordset M8 socket straight to M12 plug straight A-coded, 4-pin, PVC cable grey
	OMH-ML7-01	Mounting aid for ML7 and ML8 series, Mounting bracket
	OMH-ML7-02	Mounting aid for ML7 and ML8 series, Mounting bracket
	ICE2-8IOL-G65L-V1D	EtherNet/IP IO-Link master with 8 inputs/outputs

Release date: 2022-12-05 Date of issue: 2022-12-05 Filename: 261243_eng.pdf

Accessories

	ICE3-8IOL-G65L-V1D	PROFINET IO IO-Link master with 8 inputs/outputs
	ICE1-8IOL-G30L-V1D	Ethernet IO-Link module with 8 inputs/outputs
	ICE1-8IOL-G60L-V1D	Ethernet IO-Link module with 8 inputs/outputs
	ICE2-8IOL-K45P-RJ45	EtherNet/IP IO-Link master with 8 inputs/outputs, DIN rail, push-in connectors
	ICE2-8IOL-K45S-RJ45	EtherNet/IP IO-Link master with 8 inputs/outputs, DIN rail, screw terminal
	ICE3-8IOL-K45P-RJ45	PROFINET IO IO-Link master with 8 inputs/outputs, DIN rail, push-in terminals
	ICE3-8IOL-K45S-RJ45	PROFINET IO IO-Link master with 8 inputs/outputs, DIN rail, screw terminal
	IO-Link-Master02-USB	IO-Link master, supply via USB port or separate power supply, LED indicators, M12 plug for sensor connection

Release date: 2022-12-05 Date of issue: 2022-12-05 Filename: 261243_eng.pdf

Refer to "General Notes Relating to Pepperl+Fuchs Product Information".

Pepperl+Fuchs Group
www.pepperl-fuchs.com

USA: +1 330 486 0001
fa-info@us.pepperl-fuchs.com

Germany: +49 621 776 1111
fa-info@de.pepperl-fuchs.com

Singapore: +65 6779 9091
fa-info@sg.pepperl-fuchs.com

Function

Adjustment possibilities

The sensor features a switching output with 2 programmable switch points. Programming the switch points, the output mode, the output logic and the beam width can be done in two different ways:

- Using the sensor's programming button
- Using the IO-link interface of the sensor. This method requires an IO-link master (e.g. IO-link-Master02-USB) and the associated software. The download link is available on the product page for the sensor at www.pepperl-fuchs.com.

Synchronization

The sensor features a synchronization input for suppressing ultrasonic mutual interference („cross talk“).

The following synchronization modes are available:

1. Automatic multiplex mode.
2. Automatic common mode
3. Externally controlled synchronization

Further Documentation

- For information on programming via programming button and synchronisation you may refer to the commissioning instruction.
- For detailed information on application and programming via IO-Link we provide a manual.