



## Manövrering

### BT115A

- För vänster- och högerroterande ventiler med 180° rotation
- Fyra fasta, med 90° förskjutning manöverfanor

Manövrering för byggserie F31

## Mått

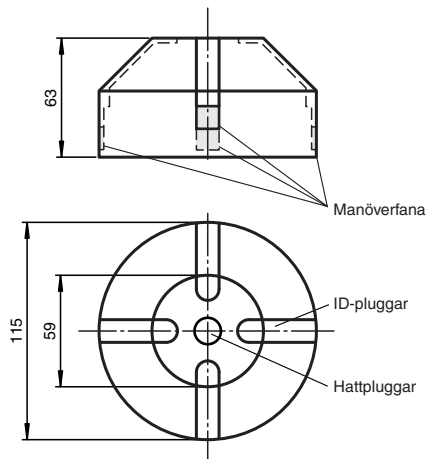

## Tekniska data

### Allmänna specifikationer

Ringdiameter	max. 110 mm
Stoppringhöjd	max. 7 mm

### Omgivningsförhållande

Omgivningstemperatur	-25 ... 70 °C (-13 ... 158 °F)
----------------------	--------------------------------

### Mekaniska specifikationer

Axeldiameter	< 90 mm
Axelhöjd	30 mm och 50 mm
Befästningshålbild	30 x 130 mm
Material	
Stomme	Fästdel: PA
Distansskiva	PA (2 st., 10 mm tjock)
Huvpluggar	PE (1 st. svart)
Identifieringspluggar	PA (2 st. gul, 2 st. svart)
Befästningsskruv	för manövrering: 1.4305 / AISI 303 (1 st. M6 x 25) för sensorer -F31: 1.4305 / AISI 303 (2 st. M5 x 16, (2 st. M5 x 12)
Manöverflagg	Rostfritt stål 1.4305 / AISI 303 (integrerad)
Stomme	120 g
Åtdragningsmoment befästningsskruvar	1,5 Nm

Kungöresedatum: 2021-04-13 Datum för utgåva: 2021-04-13 : 263361\_swe.pdf

Se "Allmänna kommentarer om produktinformationen från Pepperl+Fuchs".

Pepperl+Fuchs Group  
www.pepperl-fuchs.com



















USA: +1 330 486 0001  
fa-info@us.pepperl-fuchs.com

Tyskland: +49 621 776 1111  
fa-info@de.pepperl-fuchs.com

Singapore: +65 6779 9091  
fa-info@sg.pepperl-fuchs.com

**PF** PEPPERL+FUCHS

Passande systemkomponenter

	NBN3-F31-E8-K	
	NBN3-F31-E8-K-K	
	NBN3-F31-E8-V1	
	NBN3-F31-E8-V1-Y7011-3680	
	NBN3-F31-E8-V1-FESTO	
	NBN3-F31-E8-V16-V15	
	NBN3-F31K-E8	
	NBN3-F31K-E8-K	
	NBN3-F31K-E8-K-FESTO	
	NBN3-F31K-E8-B13-S-BRAY	
	NBN3-F31K-E8-V1-V1	
	NBN3-F31K-Z8	
	NBN3-F31K-Z8-K-FESTO	
	NBN3-F31K-Z8-V1-V1	
	NBN3-F31K2-E8-B13-S	
	NBN3-F31K2-E8-B33-S	
	NBN3-F31K2-E8-B43-S	
	NBN3-F31K2M-E8-B13-S	
	NBN3-F31K2M-E8-B23-S	
	NBN3-F31K2M-E8-B33-S	
	NBN3-F31K2M-Z8L-B43-S	
	NBN3-F31K2M-E8-B43-S	
	NBN3-F31K2M-Z8L-B13-S	

Kungörelsedatum: 2021-04-13 Datum för utgåva: 2021-04-13 : 263361\_swe.pdf

Se "Allmänna kommentarer om produktinformationen från Pepperl+Fuchs".

Pepperl+Fuchs Group  
www.pepperl-fuchs.com



















USA: +1 330 486 0001  
fa-info@us.pepperl-fuchs.com

Tyskland: +49 621 776 1111  
fa-info@de.pepperl-fuchs.com

Singapore: +65 6779 9091  
fa-info@sg.pepperl-fuchs.com

 PEPPERL+FUCHS

Passande systemkomponenter

	NBN3-F31K2M-Z8L-B23-S	
	NCN3-F31K2M-N4-B23-S	
	NBN3-F31K2M-Z8L-B33-S	
	NBN3-F31K2-Z8L-B13-S-Y300073	
	NBN3-F31K2-Z8L-B13-S-Y292890	
	NBN3-F31K2-Z8L-B13-S	
	NBN3-F31K2-Z8L-B33-S	
	NBN3-F31-U8-K	
	NBN3-F31-Z8-K	
	NBN3-F31-Z8-K-K	
	NBN3-F31-Z8-V1-FESTO	
	NCN3-F31-B3B-V1-V1-FESTO	Ventillägesvisare och ventilstyrning
	NCN3-F31-B3B-V1-V1	Ventillägesvisare och ventilstyrning
	NCN3-F31K-B3B-B31	Ventillägesvisare och ventilstyrning
	NCN3-F31K-N4	
	NCN3-F31K2-N4-B13-S	
	NCN3-F31K2-N4-B33-S	
	NCN3-F31K2M-N4-B13-S	
	NCN3-F31K2-N5-B13-S	
	NCN3-F31K2-N5-B33-S	
	NCN3-F31K-N4-B13	

Kungörelsedatum: 2021-04-13 Datum för utgåva: 2021-04-13 : 263361\_swe.pdf

Se "Allmänna kommentarer om produktinformationen från Pepperl+Fuchs".













Pepperl+Fuchs Group  
www.pepperl-fuchs.com

USA: +1 330 486 0001  
fa-info@us.pepperl-fuchs.com

Tyskland: +49 621 776 1111  
fa-info@de.pepperl-fuchs.com

Singapore: +65 6779 9091  
fa-info@sg.pepperl-fuchs.com

Passande systemkomponenter

	NCN3-F31K-N4-B13-S	
	NCN3-F31K-N4-K-FESTO	
	NCN3-F31K-N4-K	
	NCN3-F31K-N4-K-S	
	NCN3-F31K-N4-S	
	NCN3-F31K-N4-V1-V1	
	NCN3-F31K-N5-K	
	NCN3-F31-N4-K	
	NCN3-F31-N4-K-K	
	NCN3-F31-N4-V1	
	NCN3-F31-N4-V1-FESTO	
	NBN3-F31K2M-E8-B13-S-3G-3D	
	NBN3-F31K2M-Z8L-B13-S-3G-3D	
	NBN3-F31K2M-Z8L-B13-S-3G-3D-Y	
	NBN3-F31K2M-Z8L-B13-S-3G-3D-Y	

Kungörelsedatum: 2021-04-13 Datum för utgåva: 2021-04-13 : 263361\_swe.pdf

Se "Allmänna kommentarer om produktinformationen från Pepperl+Fuchs".

Pepperl+Fuchs Group  
www.pepperl-fuchs.com

USA: +1 330 486 0001  
fa-info@us.pepperl-fuchs.com

Tyskland: +49 621 776 1111  
fa-info@de.pepperl-fuchs.com

Singapore: +65 6779 9091  
fa-info@sg.pepperl-fuchs.com

## Funktion

Aktivatorn är gjord av ledande plastmaterial som förhindrar statisk elektricitet och gör att den kan monteras i potentiellt explosiva miljöer.