

# SMART Transmitter Power Supply KCD2-STC-Ex1.20

- 1-channel isolated barrier
- 24 V DC supply (Power Rail)
- Input for 2-wire SMART transmitters and current sources
- Signal splitter (1 input and 2 outputs)
- Dual output 0/4 mA ... 20 mA or 0/1 V ... 5 V
- Terminal blocks with test sockets
- Up to SIL 2 (SC 3) acc. to IEC/EN 61508



## Function

This isolated barrier is used for intrinsic safety applications. The device supplies 2-wire transmitters in the hazardous area, and can also be used with current sources. It transfers the analog input signal to the safe area as two isolated output signals. Bi-directional communication is supported for SMART transmitters that use current modulation to transmit data and voltage modulation to receive data. The output is selected as a current source, current sink, or voltage source via switches. Test sockets for the connection of HART communicators are integrated into the terminals of the device.

## Application

The device supports the following SMART protocols:

- HART
- BRAIN

## Connection

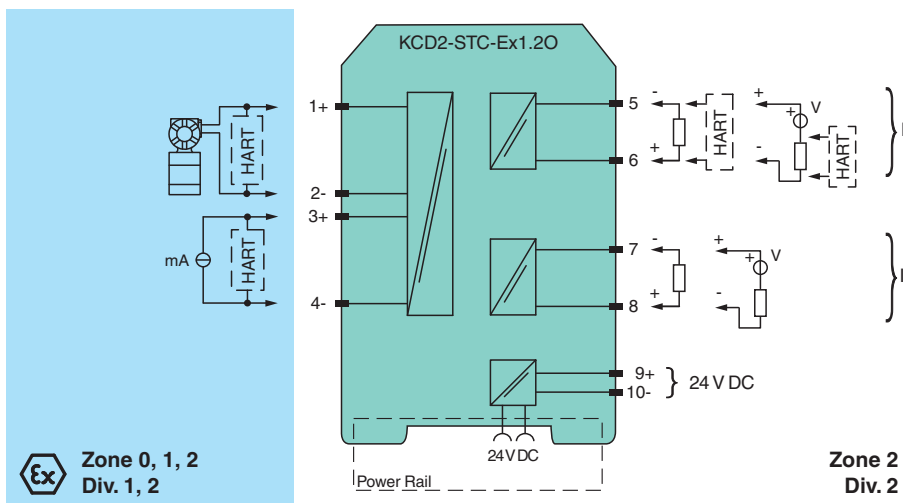

## Technical Data

General specifications	
Signal type	Analog input
Functional safety related parameters	
Safety Integrity Level (SIL)	SIL 2
Systematic capability (SC)	SC 3
Supply	

Refer to "General Notes Relating to Pepperl+Fuchs Product Information".

## Technical Data

Connection		Power Rail or terminals 9+, 10-
Rated voltage	$U_r$	19 ... 30 V DC
Ripple		within the supply tolerance
Power dissipation		approx. 1.4 W at 20 mA transfer current, 250 $\Omega$ in both outputs
Power consumption		2 W
<b>Input</b>		
Connection side		field side
Connection		terminals 1+, 2- (sink); 3+, 4- (source)
Input signal		0/4 ... 20 mA
Voltage drop		terminals 3, 4: $\leq 6.1$ V at 20 mA
Short-circuit current		terminals 1+, 2-: 25 mA
Input resistance		terminals 1+, 2-: max. 500 $\Omega$ (BRAIN) (250 $\Omega$ load)
Available voltage		terminals 1+, 2-: $\geq 16$ V at 20 mA , $\geq 18.5$ V at 4 mA
<b>Output</b>		
Connection side		control side
Connection		source: terminals 5-, 6+; 7-, 8+ sink: terminals 5+, 6-, 7+, 8-
Load		channel 1: 0 ... 500 $\Omega$ (20 mA)/> 1 M $\Omega$ (5 V) channel 2: 0 ... 500 $\Omega$ (20 mA)/> 1 M $\Omega$ (5 V)
Output signal		0/4 ... 20 mA or 0/1 ... 5 V
Ripple		max. 50 $\mu$ A <sub>rms</sub>
<b>Transfer characteristics</b>		
Deviation		$I_{out} < 20$ $\mu$ A (0.1 %); $V_{out} < 10$ mV (0.2 %) incl. calibration, linearity, hysteresis and fluctuation of supply voltage, at 20 °C (68 °F), 0/4 ... 20 mA, 0/1 ... 5 V
Influence of ambient temperature		current output: 0.25 $\mu$ A/K voltage output: 80 $\mu$ V/K
Frequency range		field side into the control side: bandwidth with 0.5 V <sub>pp</sub> signal 0 ... 6 kHz (-3 dB) control side into the field side: bandwidth with 0.5 V <sub>pp</sub> signal 0.3 ... 6 kHz (-3 dB)
Settling time		6 ms
Rise time/fall time		2 ms
<b>Galvanic isolation</b>		
Output/power supply		functional insulation, rated insulation voltage 50 V AC
Output/Output		functional insulation, rated insulation voltage 50 V AC
<b>Indicators/settings</b>		
Display elements		LED
Control elements		DIP switch
Configuration		via DIP switches
Labeling		space for labeling at the front
<b>Directive conformity</b>		
Electromagnetic compatibility		
Directive 2014/30/EU		EN 61326-1:2013 (industrial locations)
<b>Conformity</b>		
Electromagnetic compatibility		NE 21:2012 EN 61326-3-2:2008
Degree of protection		IEC 60529:2001
Protection against electrical shock		UL 61010-1:2012
<b>Ambient conditions</b>		
Ambient temperature		-20 ... 60 °C (-4 ... 140 °F) extended ambient temperature range up to 70 °C (158 °F), refer to manual for necessary mounting conditions
<b>Mechanical specifications</b>		
Degree of protection		IP20
Connection		screw terminals
Mass		approx. 100 g
Dimensions		12.5 x 124 x 114 mm (0.5 x 4.9 x 4.5 inch) (W x H x D) , housing type A2

Release date: 2023-06-01 Date of issue: 2023-06-01 Filename: 272955\_eng.pdf

## Technical Data





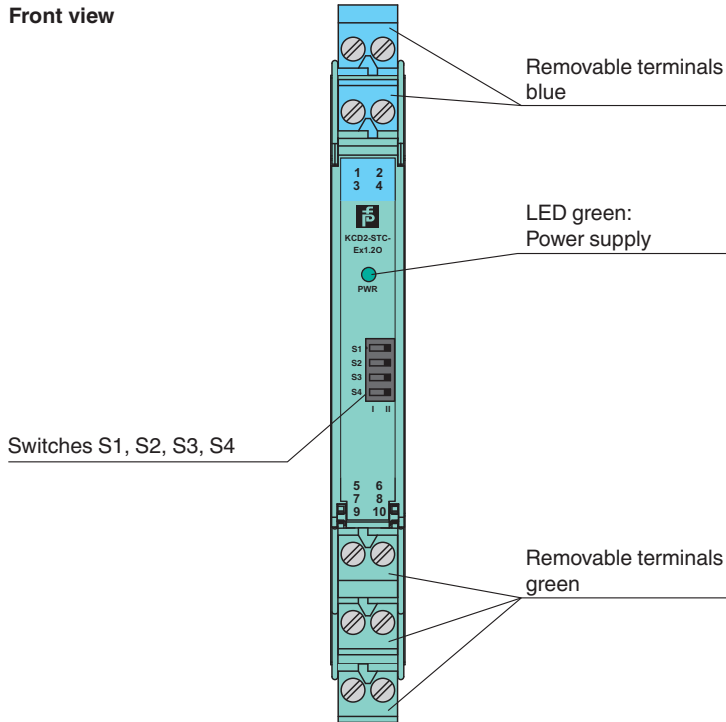

Mounting	on 35 mm DIN mounting rail acc. to EN 60715:2001	
<b>Data for application in connection with hazardous areas</b>		
EU-type examination certificate	BASEEFA 13 ATEX 0077 X	
Marking	Ⓜ II (1)G [Ex ia Ga] IIC Ⓜ II (1)D [Ex ia Da] IIIC Ⓜ I (M1) [Ex ia Ma] I	
Input	[Ex ia Ga] IIC, [Ex ia Da] IIIC, [Ex ia Ma] I	
Supply		
Maximum safe voltage	$U_m$	250 V (Attention! The rated voltage can be lower.)
Equipment	terminals 1+, 2-	
Voltage	$U_o$	25.2 V
Voltage	$U_q$	28.2 V
Current	$I_o$	93 mA
Power	$P_o$	656 mW
Internal capacitance	$C_i$	10 nF
Internal inductance	$L_i$	0 mH
Equipment	terminals 3+, 4-	
Voltage	$U_i$	30 V
Current	$I_i$	115 mA
Power	$P_i$	700 mW
Voltage	$U_o$	5 V
Current	$I_o$	6.8 mA
Power	$P_o$	1.6 mW
Output		
Maximum safe voltage	$U_m$	250 V (Attention! The rated voltage can be lower.)
Certificate	BASEEFA 13 ATEX 0078 X	
Marking	Ⓜ II 3G Ex nA IIC T4 Gc	
Galvanic isolation		
Input/Output	safe electrical isolation acc. to IEC/EN 60079-11, voltage peak value 375 V	
Input/power supply	safe electrical isolation acc. to IEC/EN 60079-11, voltage peak value 375 V	
Directive conformity		
Directive 2014/34/EU	EN IEC 60079-0:2018+AC:2020 , EN 60079-11:2012 , EN 60079-15:2010	
<b>International approvals</b>		
UL approval		
Control drawing	116-0380 (cULus)	
IECEx approval		
IECEx certificate	IECEx BAS 13.0043X	
IECEx marking	[Ex ia Ga] IIC, [Ex ia Da] IIIC, [Ex ia Ma] I	
<b>General information</b>		
Note	Both output loads must be connected to ensure complete and correct operation within the technical specification.	
Supplementary information	Observe the certificates, declarations of conformity, instruction manuals, and manuals where applicable. For information see <a href="http://www.pepperl-fuchs.com">www.pepperl-fuchs.com</a> .	

**Assembly**





Front view



**Matching System Components**

	<b>KFD2-EB2</b>	Power Feed Module
	<b>UPR-03</b>	Universal Power Rail with end caps and cover, 3 conductors, length: 2 m
	<b>UPR-03-M</b>	Universal Power Rail with end caps and cover, 3 conductors, length: 1,6 m
	<b>UPR-03-S</b>	Universal Power Rail with end caps and cover, 3 conductors, length: 0.8 m
	<b>K-DUCT-BU</b>	Profile rail, wiring comb field side, blue
	<b>K-DUCT-BU-UPR-03</b>	Profile rail with UPR-03- * insert, 3 conductors, wiring comb field side, blue

**Accessories**

	<b>KC-ST-5GN</b>	Terminal block for KC modules, 2-pin screw terminal, green
	<b>KC-STP-5GN</b>	Terminal block for KC modules, 2-pin screw terminal, with test sockets, green
	<b>KC-ST-5BU</b>	Terminal block for KC modules, 2-pin screw terminal, blue
	<b>KC-STP-5BU</b>	Terminal block for KC modules, 2-pin screw terminal, with test sockets, blue

Release date: 2023-06-01 Date of issue: 2023-06-01 Filename: 272955\_eng.pdf

Refer to "General Notes Relating to Pepperl+Fuchs Product Information".

**Accessories**

	<p><b>KF-CP</b></p>	<p>Red coding pins, packaging unit: 20 x 6</p>
---	---------------------	--

Release date: 2023-06-01 Date of issue: 2023-06-01 Filename: 272955\_eng.pdf

Refer to "General Notes Relating to Pepperl+Fuchs Product Information".

Pepperl+Fuchs Group  
www.pepperl-fuchs.com

USA: +1 330 486 0002  
pa-info@us.pepperl-fuchs.com

Germany: +49 621 776 2222  
pa-info@de.pepperl-fuchs.com

Singapore: +65 6779 9091  
pa-info@sg.pepperl-fuchs.com

**Configuration**

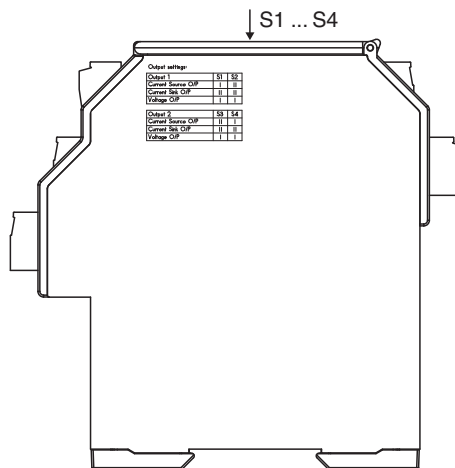

**Output switch settings**

Output 1	S1	S2
Current source output	I	II
Current sink output	II	II
Voltage output	I	I
Not valid	II	I

Output 2	S3	S4
Current source output	II	I
Current sink output	II	II
Voltage output	I	I
Not valid	I	II

Factory settings: current source output, for both channels.

Release date: 2023-06-01 Date of issue: 2023-06-01 Filename: 272955\_eng.pdf