

Backplane

FB9271BP00200.0

- Backplane for FB9205 Power Supply
- Slots for 2 power supplies
- Power supplies can be operated separately or parallel
- Redundant supply
- Installation in Zone 1



Connection Assignment

Wiring Power Good Signal

Only in Conjunction with FB9204C3 or FB9205C3

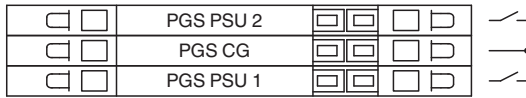

Wiring and Jumper Settings

Seperate PSU, common ground

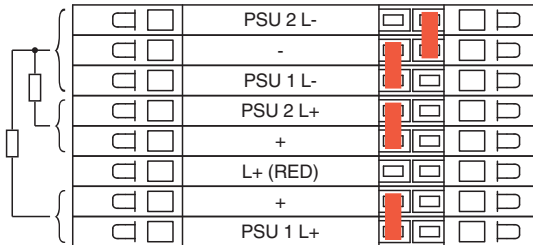

Seperate PSU, seperate ground

Ground connection doubled for PSU 1

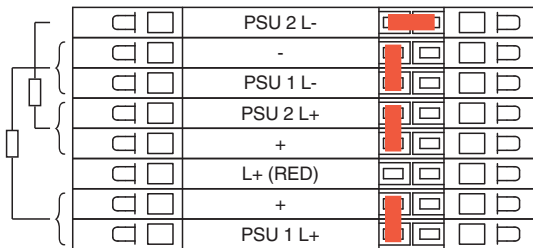

Ground connection doubled for PSU 2

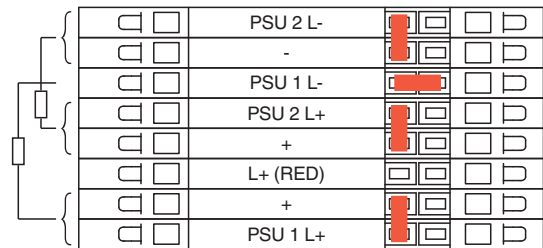

Parallel / Redundant PSUs

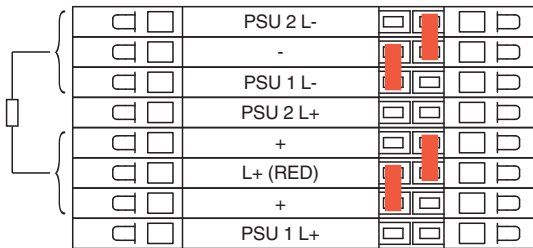

Power Connection

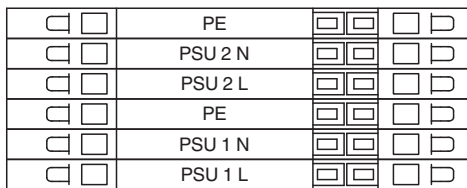

Legend	
PSU:	Power Supply Unit

Release date: 2023-06-13 Date of issue: 2023-06-13 Filename: 276979_eng.pdf

Dimensions

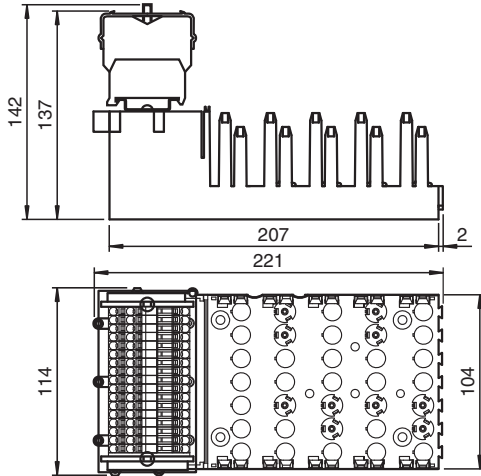

Technical Data

Slots	
Supply	2
Supply	
Maximum safe voltage U_m	253 V AC
Input voltage range	U 95 ... 253 V AC
Redundancy	yes
Output	
Voltage	non-redundant: 24 V ; redundant: 23 V
Current	non-redundant: 2.4 A ; redundant: 1.2 A
Directive conformity	
Electromagnetic compatibility	
Directive 2014/30/EU	EN 61326-1:2013
Conformity	
Degree of protection	EN 60529
Ambient conditions	
Ambient temperature	-20 ... 60 °C (-4 ... 140 °F)
Shock resistance	shock type I, shock duration 11 ms, shock amplitude 15 g, number of shocks 18
Vibration resistance	frequency range 10 ... 150 Hz; transition frequency: 57.56 Hz, amplitude/acceleration ± 0.075 mm/1 g; 10 cycles frequency range 5 ... 100 Hz; transition frequency: 13.2 Hz amplitude/acceleration ± 1 mm/0.7 g; 90 minutes at each resonance
Mechanical specifications	
Connection type	Terminals
Core cross section	0.5 ... 2.5 mm ²
Degree of protection	IP30
Mass	approx. 512 g , without modules
Dimensions	(l x w x h) 207 x 110 x 137 mm , without modules
Data for application in connection with hazardous areas	
EU-type examination certificate	BVS 11 ATEX E 041 X
Marking	Ⓜ II 2G Ex db eb IIC T4 Gb
Directive conformity	
Directive 2014/34/EU	EN IEC 60079-0:2018+AC:2020 EN 60079-1:2014 EN 60079-7:2015+A1:2018 EN 60079-18:2015+A1:2017
International approvals	
IECEx approval	
IECEx certificate	BVS 11.0019X

Release date: 2023-06-13 Date of issue: 2023-06-13 Filename: 276979_eng.pdf

Technical Data

IECEX marking	Ex db eb IIC T4 Gb
INMETRO approval	Brazil: TÜV 14.1598X
Marine approval	
Bureau Veritas Marine	22449/B0 BV
General information	
Scope of delivery	Backplane (without modules and surrounding enclosure)
Supplementary information	Statement of Conformity, Declaration of Conformity, Attestation of Conformity and instructions have to be observed where applicable. For information see www.pepperl-fuchs.com .

Release date: 2023-06-13 Date of issue: 2023-06-13 Filename: 276979_eng.pdf

Refer to "General Notes Relating to Pepperl+Fuchs Product Information".

Pepperl+Fuchs Group
www.pepperl-fuchs.com

USA: +1 330 486 0002
pa-info@us.pepperl-fuchs.com

Germany: +49 621 776 2222
pa-info@de.pepperl-fuchs.com

Singapore: +65 6779 9091
pa-info@sg.pepperl-fuchs.com

