

AS-Interface splitter box

VAZ-2T1-FK-G10-F-2M-PUR-V1-G



- One piece housing
- Simple and fast mounting
- Fuses with LED display
- Gold-plated and machined contacts
- Oil and abrasion resistant PUR line appropriate for drag chains
- Immunity to vibration
- Degree of protection IP68 / IP69K
- Halogen-free

G10 junction block, LED status indication, AS-Interface, and auxiliary power to 1x M12 round plug connector



Dimensions

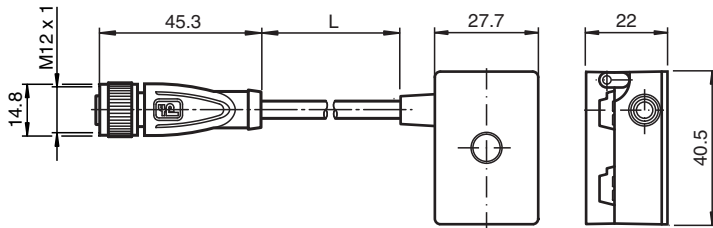

Technical Data

General specifications			
Construction type		Socket, straight Flat cable terminals AS-Interface/ext. auxiliary voltage	
UL File Number		E223772 "For use in NFPA 79 Applications only"	
Indicators/operating means			
LED FAULT		LED red: Fuse unit blown	
LED PWR		LED green: normal operation	
Electrical specifications			
Rated operating voltage	U_e	10 ... 32 V PELV (AS-Interface , ext. auxiliary voltage AUX)	
Protection class		III	
Short-circuit current	I_k	max. 50 A	
Surge protection		U_e : Over voltage category III, safe isolated power supplies (PELV)	
Output			
Current loading capacity		Rated current of the fuse: 1.6 A Continuous operation: 1.2 A	
Voltage drop	U_d	≤ 0.6 V	

Release date: 2023-11-21 Date of issue: 2023-11-21 Filename: 279017_eng.pdf

Refer to "General Notes Relating to Pepperl+Fuchs Product Information".

Pepperl+Fuchs Group
www.pepperl-fuchs.com

USA: +1 330 486 0001
fa-info@us.pepperl-fuchs.com

Germany: +49 621 776 1111
fa-info@de.pepperl-fuchs.com

Singapore: +65 6779 9091
fa-info@sg.pepperl-fuchs.com

PF PEPPERL+FUCHS

Technical Data

Overload protection	Fuse acc. to UL248-1, UL248-14
Compliance with standards and directives	
Directive conformity	
EMC Directive 2004/108/EC	EN 61000-6-2:2005, EN 61000-6-4:2007
Standard conformity	
Noise immunity	EN 61000-6-2:2005
Emitted interference	EN 61000-6-4:2007
Degree of protection	EN 60529:2000
Approvals and certificates	
UL approval	cULus Listed, Type 1 enclosure
Maximum permissible ambient temperature	max. 55 °C (max. 131 °F)
Ambient conditions	
Ambient temperature	-25 ... 70 °C (-13 ... 158 °F)
Storage temperature	-25 ... 85 °C (-13 ... 185 °F)
Mechanical specifications	
Degree of protection	IP67 IP67 / IP68 / IP69K with flat cable VAZ-FK-S-*
Connection	Flat cable AS-Interface: cable piercing method Flat cable ext. auxiliary voltage U_{AUX} : Insulation penetration technology Plug connection: M12 x 1 socket (V1)
Material	
Contacts	CuSn / Au
Housing	PBT PC
Body	PUR, black
Cable	PUR
Mounting screw	Stainless steel 1.4305 / AISI 303
Cable	
Sheath diameter	Ø4,3 mm
Color	black
Cores	4 x 0.34 mm ²
Length	L 2 m
Mass	100 g
Tightening torque, fastening screws	1.65 Nm
Tightening torque, cable gland	0.4 Nm

Connection

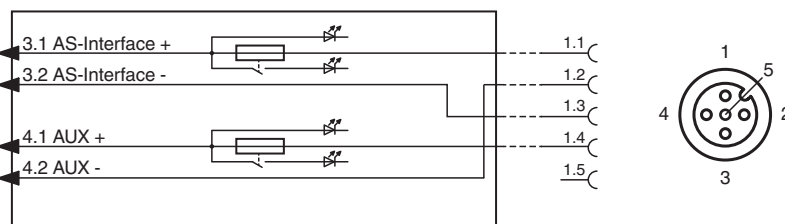

Assembly

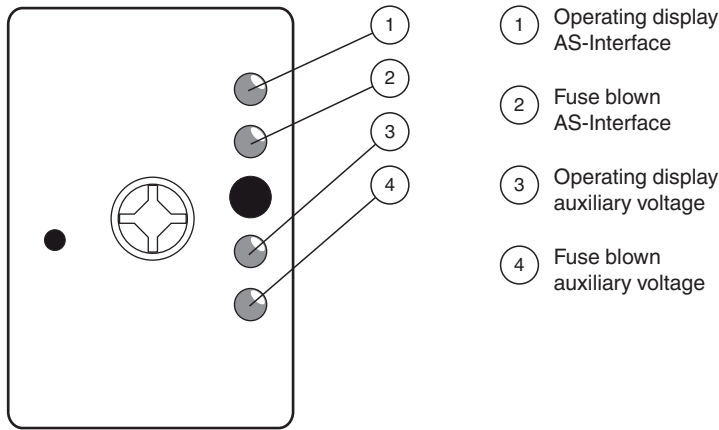

Mounting

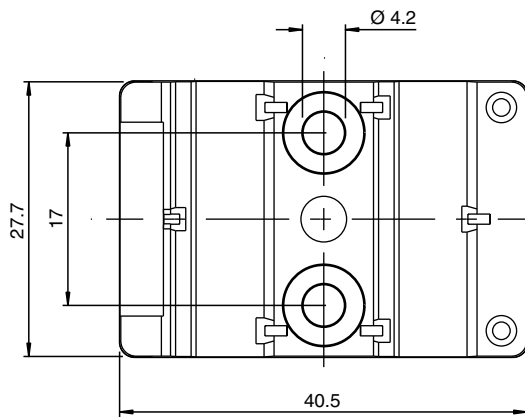

You may screw the device onto a level mounting surface using two M4 attachment screws. The attachment screws are not included.

Release date: 2023-11-21 Date of issue: 2023-11-21 Filename: 279017_eng.pdf