

# SMART Transmitter Power Supply

## KFD2-STV4-Ex1-1

- 1-channel isolated barrier
- 24 V DC supply (Power Rail)
- Input 2-wire and 3-wire SMART transmitters and 2-wire SMART current sources
- Output 0/1 V ... 5 V
- Terminals with test points
- Up to SIL 2 acc. to IEC/EN 61508



### Function

This isolated barrier is used for intrinsic safety applications. The device supplies 2-wire and 3-wire SMART transmitters in a hazardous area, and can also be used with 2-wire SMART current sources. It transfers the analog input signal to the safe area as an isolated voltage value. Digital signals may be superimposed on the input signal in the hazardous or safe area and are transferred bi-directionally. If the HART communication resistance in the loop is too low, the internal resistance of 250 Ω between terminals 8 and 9 can be used. Test sockets for the connection of HART communicators are integrated into the terminals of the device.

### Application

The device supports the following SMART protocols:

- HART
- BRAIN
- Foxboro

### Connection

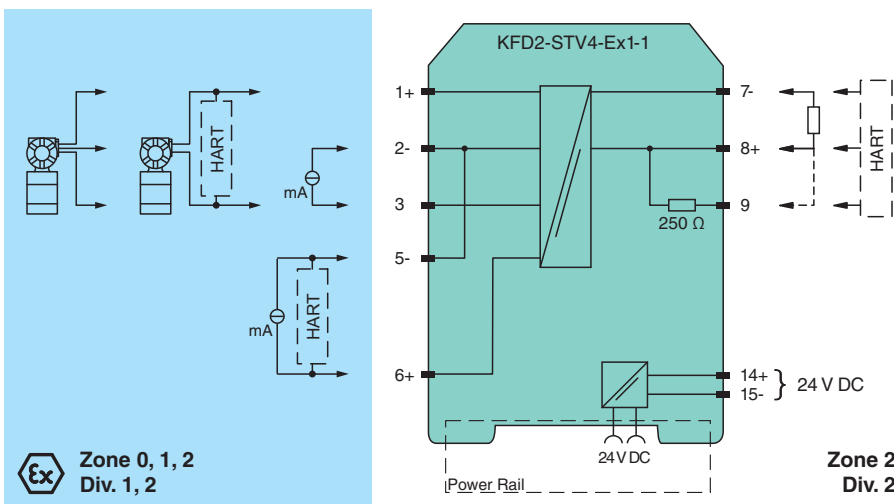

### Technical Data

#### General specifications

Signal type Analog input

#### Functional safety related parameters

Safety Integrity Level (SIL) SIL 2

#### Supply

Release date: 2023-06-05 Date of issue: 2023-06-05 Filename: 283702\_eng.pdf

Refer to "General Notes Relating to Pepperl+Fuchs Product Information".

Pepperl+Fuchs Group  
www.pepperl-fuchs.com

USA: +1 330 486 0002  
pa-info@us.pepperl-fuchs.com

Germany: +49 621 776 2222  
pa-info@de.pepperl-fuchs.com

Singapore: +65 6779 9091  
pa-info@sg.pepperl-fuchs.com

**PEPPERL+FUCHS**

## Technical Data

Connection		Power Rail or terminals 14+, 15-
Rated voltage	$U_r$	20 ... 35 V DC
Ripple		within the supply tolerance
Power dissipation		1.5 W
Power consumption		1.8 W
<b>Input</b>		
Connection side		field side
Connection		terminals 1+, 2-, 3 or 5-, 6+
Input signal		0/4 ... 20 mA
Voltage drop		≤ 2.4 V at 20 mA (terminals 5, 6)
Input resistance		≤ 64 Ω terminals 2-, 3 ; ≤ 500 Ω terminals 1+, 3 (250 Ω load)
Available voltage		≥ 16 V at 20 mA terminals 1+, 3
<b>Output</b>		
Connection side		control side
Connection		terminals 7-, 8+, 9
Load		output resistance: 250 Ω
Output signal		0/1 ... 5 V
Ripple		max. 12.5 mV
<b>Transfer characteristics</b>		
Deviation		at 20 °C (68 °F), 0/1 ... 5 V ≤ 5 mV incl. calibration, linearity, hysteresis, loads and fluctuations of supply voltage
Influence of ambient temperature		≤ 20 ppm/K
Frequency range		field side into the control side: bandwidth with 0.5 V <sub>pp</sub> signal 0 ... 7.5 kHz (-3 dB) control side into the field side: bandwidth with 0.5 V <sub>pp</sub> signal 0.3 ... 7.5 kHz (-3 dB)
Rise time		20 μs
Settling time		200 μs
De-energized delay		20 μs
<b>Galvanic isolation</b>		
Input/Output		safe electrical isolation acc. to IEC/EN 60079-11, voltage peak value 375 V
Input/power supply		safe electrical isolation acc. to IEC/EN 60079-11, voltage peak value 375 V
Output/power supply		functional insulation, rated insulation voltage 50 V AC
<b>Indicators/settings</b>		
Display elements		LED
Labeling		space for labeling at the front
<b>Directive conformity</b>		
Electromagnetic compatibility		
Directive 2014/30/EU		EN 61326-1:2013 (industrial locations)
<b>Conformity</b>		
Electromagnetic compatibility		NE 21:2011
Degree of protection		IEC 60529:2001
Protection against electrical shock		UL 61010-1:2012
<b>Ambient conditions</b>		
Ambient temperature		-20 ... 60 °C (-4 ... 140 °F)
<b>Mechanical specifications</b>		
Degree of protection		IP20
Connection		screw terminals
Mass		approx. 200 g
Dimensions		20 x 124 x 115 mm (0.8 x 4.9 x 4.5 inch) (W x H x D) , housing type B2
Mounting		on 35 mm DIN mounting rail acc. to EN 60715:2001
<b>Data for application in connection with hazardous areas</b>		
EU-type examination certificate		BAS 99 ATEX 7060 X
Marking		⊕ II (1)G [Ex ia Ga] IIC , ⊕ II (1)D [Ex ia Da] IIIC , ⊕ I (M1) [Ex ia Ma] I
Input		[Ex ia Ga] IIC, [Ex ia Da] IIIC, [Ex ia Ma] I
Supply		

Release date: 2023-06-05 Date of issue: 2023-06-05 Filename: 283702\_eng.pdf

Refer to "General Notes Relating to Pepperl+Fuchs Product Information".

 Pepperl+Fuchs Group  
www.pepperl-fuchs.com

 USA: +1 330 486 0002  
pa-info@us.pepperl-fuchs.com

 Germany: +49 621 776 2222  
pa-info@de.pepperl-fuchs.com

 Singapore: +65 6779 9091  
pa-info@sg.pepperl-fuchs.com

 **PEPPERL+FUCHS**

**Technical Data**

Maximum safe voltage	U <sub>m</sub>	250 V (Attention! The rated voltage can be lower.)
Equipment		terminals 1+, 3-
Voltage	U <sub>o</sub>	25.4 V
Current	I <sub>o</sub>	86.8 mA
Power	P <sub>o</sub>	551 mW
Internal capacitance	C <sub>i</sub>	12 nF
Internal inductance	L <sub>i</sub>	0
Equipment		terminals 2-, 3
Current	I <sub>o</sub> /Strom I <sub>i</sub>	74 mA / 115 mA
Current	I <sub>i</sub>	115 mA
Voltage	U <sub>o</sub>	3.5 V
Current	I <sub>o</sub>	74 mA
Power	P <sub>o</sub>	64 mW
Equipment		terminals 1+, 2 / 3-
Voltage	U <sub>i</sub>	30 V
Current	I <sub>i</sub>	115 mA
Voltage	U <sub>o</sub>	25.4 V
Current	I <sub>o</sub>	115 mA
Power	P <sub>o</sub>	584 mW
Equipment		terminals 5-, 6+
Voltage	U <sub>i</sub>	30 V
Current	I <sub>i</sub>	115 mA
Voltage	U <sub>o</sub>	8.7 V
Current	I <sub>o</sub>	0 mA
Certificate		TÜV 99 ATEX 1499 X
Marking		Ⓜ II 3G Ex nA II T4 [device in zone 2]
Galvanic isolation		
Input/Output		safe electrical isolation acc. to IEC/EN 60079-11, voltage peak value 375 V
Input/power supply		safe electrical isolation acc. to IEC/EN 60079-11, voltage peak value 375 V
Directive conformity		
Directive 2014/34/EU		EN 60079-0:2012+A11:2013 , EN 60079-11:2012 , EN 60079-15:2010
<b>International approvals</b>		
UL approval		
Control drawing		116-0428 (cULus)
IECEX approval		
IECEX certificate		IECEX BAS 04.0016X IECEX CML 15.0055X
IECEX marking		[Ex ia Ga] IIC , [Ex ia Da] IIIC , [Ex ia Ma] I Ex nA IIC T4 Gc
<b>General information</b>		
Supplementary information		Observe the certificates, declarations of conformity, instruction manuals, and manuals where applicable. For information see <a href="http://www.pepperl-fuchs.com">www.pepperl-fuchs.com</a> .





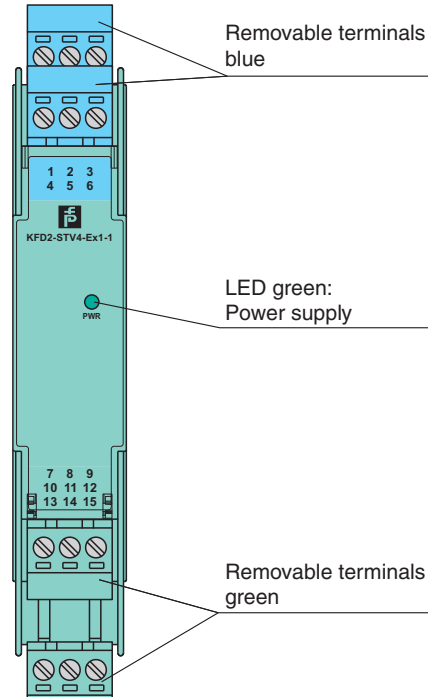

Release date: 2023-06-05 Date of issue: 2023-06-05 Filename: 283702\_eng.pdf

**Assembly**





Front view



**Matching System Components**

	<b>KFD2-EB2</b>	Power Feed Module
	<b>UPR-03</b>	Universal Power Rail with end caps and cover, 3 conductors, length: 2 m
	<b>UPR-03-M</b>	Universal Power Rail with end caps and cover, 3 conductors, length: 1,6 m
	<b>UPR-03-S</b>	Universal Power Rail with end caps and cover, 3 conductors, length: 0.8 m
	<b>K-DUCT-BU</b>	Profile rail, wiring comb field side, blue
	<b>K-DUCT-BU-UPR-03</b>	Profile rail with UPR-03- * insert, 3 conductors, wiring comb field side, blue

**Accessories**

	<b>KF-STP-5BU</b>	Terminal block for KF modules, 3-pin screw terminal, with test sockets, blue
	<b>KF-STP-5GN</b>	Terminal block for KF modules, 3-pin screw terminal, with test sockets, green
	<b>KF-ST-5GN</b>	Terminal block for KF modules, 3-pin screw terminal, green
	<b>KF-CP</b>	Red coding pins, packaging unit: 20 x 6

Release date: 2023-06-05 Date of issue: 2023-06-05 Filename: 283702\_eng.pdf