

Inductive sensor

NBN20-30GM40-A0-V1

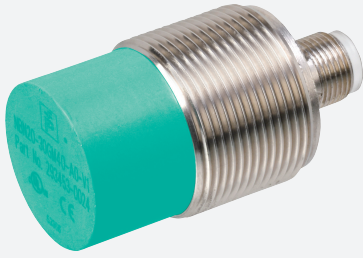

■ 15 mm non-flush



Dimensions

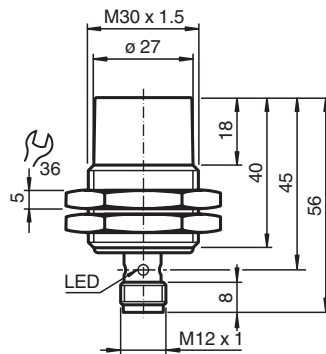

Technical Data

General specifications

Switching function		complementary
Output type		NPN
Rated operating distance	s_n	20 mm
Installation		non-flush
Output polarity		DC
Assured operating distance	s_a	0 ... 16.2 mm
Actuating element		mild steel, e. g. 1.0037, SR235JR (formerly St37-2) 60 mm x 60 mm x 1 mm
Reduction factor r_{Al}		0.45
Reduction factor r_{Cu}		0.4
Reduction factor r_{304}		0.7
Reduction factor r_{Brass}		0.5
Output type		4-wire

Nominal ratings

Operating voltage	U_B	10 ... 30 V
Switching frequency	f	0 ... 1000 Hz

Release date: 2020-03-24 Date of issue: 2020-03-30 Filename: 293453-0024_eng.pdf

Refer to "General Notes Relating to Pepperl+Fuchs Product Information".

Pepperl+Fuchs Group
www.pepperl-fuchs.com

USA: +1 330 486 0001
fa-info@us.pepperl-fuchs.com

Germany: +49 621 776 1111
fa-info@de.pepperl-fuchs.com

Singapore: +65 6779 9091
fa-info@sg.pepperl-fuchs.com

PEPPERL+FUCHS

Technical Data

Hysteresis	H	typ. 5%
Reverse polarity protection		reverse polarity protected
Short-circuit protection		pulsing
Voltage drop	U_d	≤ 1.8 V
Operating current	I_L	0 ... 200 mA
Off-state current	I_r	0 ... 0.5 mA typ. 0.1 μ A at 25 °C
No-load supply current	I_o	≤ 10 mA
Time delay before availability	t_v	≤ 60 ms
Switching state indicator		Multihole-LED, yellow
Functional safety related parameters		
MTTF _d		1720 a
Mission Time (T _M)		20 a
Diagnostic Coverage (DC)		0 %
Compliance with standards and directives		
Standard conformity		
Standards		EN 60947-5-2:2007 EN 60947-5-2/A1:2012 IEC 60947-5-2:2007 IEC 60947-5-2 AMD 1:2012
Approvals and certificates		
UL approval		cULus Listed, General Purpose, Class 2 Power Source
CCC approval		CCC approval / marking not required for products rated ≤ 36 V
Ambient conditions		
Ambient temperature		-25 ... 70 °C (-13 ... 158 °F)
Mechanical specifications		
Connection type		Connector M12 x 1 , 4-pin
Housing material		brass, nickel-plated
Sensing face		PBT
Degree of protection		IP67
Mass		90 g
General information		
Scope of delivery		2 self locking nuts in scope of delivery

Connection

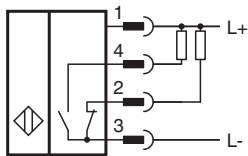

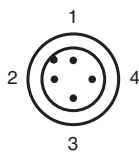

Connection Assignment



Wire colors in accordance with EN 60947-5-2

1	BN	(brown)
2	WH	(white)
3	BU	(blue)
4	BK	(black)

Accessories

	BF 30	Mounting flange, 30 mm
	V1-G-2M-PUR	Female cordset, M12, 4-pin, PUR cable
	V1-W-2M-PUR	Female cordset, M12, 4-pin, PUR cable

Release date: 2020-03-24 Date of issue: 2020-03-30 Filename: 293453-0024_eng.pdf

Refer to "General Notes Relating to Pepperl+Fuchs Product Information".

Pepperl+Fuchs Group
www.pepperl-fuchs.com

USA: +1 330 486 0001
fa-info@us.pepperl-fuchs.com

Germany: +49 621 776 1111
fa-info@de.pepperl-fuchs.com

Singapore: +65 6779 9091
fa-info@sg.pepperl-fuchs.com