

Connection cable, shielded

V1-W-BK0,8M-PUR-U5/ABG-V1-W



- Degree of protection IP68 / IP69
- Resistant to microbes and hydrolysis
- UV resistant
- UL listed for USA and Canada
- Halogen-free
- Shield connected to screw connection
- Specific design protects against loosening and inaccurate installation

Cordset M12 socket angled to M12 plug angled A-coded, 4-pin, PUR cable black, shielded, UL-approved



Dimensions

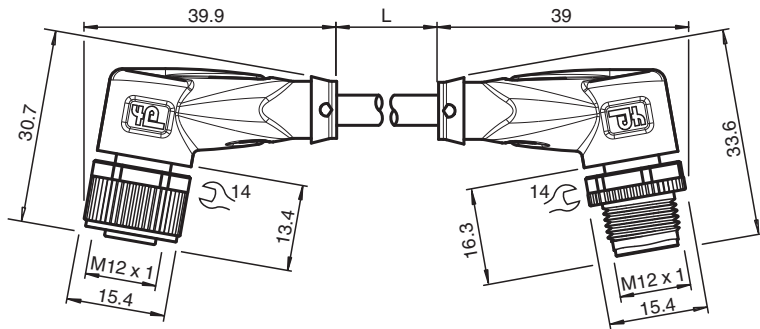

Technical Data

General specifications

| | | |
|-------------------|--|------------------|
| Connector 1 | | |
| Connection | | socket |
| Construction type | | M12 |
| Style | | angled |
| Locking | | screw connection |
| Number of pins | | 4 |
| Coding | | A-coded |
| Connector 2 | | |
| Connection | | plug |
| Construction type | | M12 |
| Style | | angled |
| Locking | | screw connection |
| Number of pins | | 4 |
| Coding | | A-coded |

Electrical specifications

| | | |
|-------------------|-------|------------------------|
| Operating voltage | U_B | max. 48 V AC / 60 V DC |
| Operating current | I_B | max. 4 A |

Conformity

| | | |
|----------------------|--|-------------------------------------|
| Degree of protection | | EN 60529 |
| Plug connection | | connector M12 x 1 : IEC 61076-2-101 |

Release date: 2023-07-13 Date of issue: 2023-07-13 Filename: 297877_eng.pdf

Refer to "General Notes Relating to Pepperl+Fuchs Product Information".

Pepperl+Fuchs Group
www.pepperl-fuchs.com

USA: +1 330 486 0001
fa-info@us.pepperl-fuchs.com

Germany: +49 621 776 1111
fa-info@de.pepperl-fuchs.com

Singapore: +65 6779 9091
fa-info@sg.pepperl-fuchs.com

PF PEPPERL+FUCHS

Technical Data





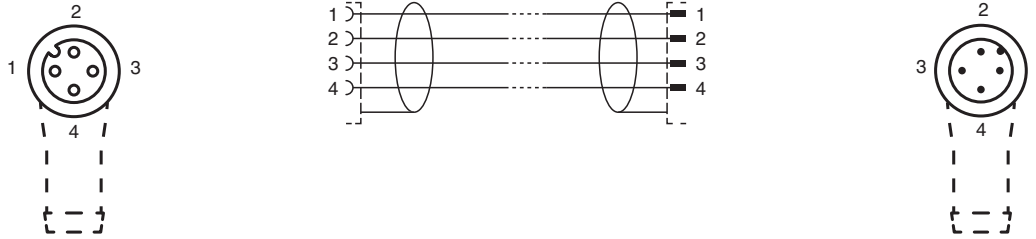

| | | |
|-----------------------------------|---|-------|
| Flammability | UL 1581; DIN EN 60332-2-2 | |
| Halogen-free | DIN VDE 0472-815 / DIN EN 50267-2-1 | |
| Approvals and certificates | | |
| UL approval | AWM STYLE 21924/11558 105°C 300V AWM I A/B 105°C 300V FT2 (cable) | |
| UL File Number | E231213 | |
| Ambient conditions | | |
| Ambient temperature | | |
| Plug connector | -40 ... 90 °C (-40 ... 194 °F) | |
| Cable, fixed | -50 ... 105 °C (-58 ... 221 °F) | |
| Cable, flexing | -30 ... 105 °C (-22 ... 221 °F) | |
| Pollution degree | 3 | |
| Mechanical specifications | | |
| Plug connector | | |
| Tightening torque | 0.6 Nm | |
| Loosening protection | available | |
| Tool installation | straight knurling and hexagon nut SW = 14 mm | |
| Mating cycles | min. 100 | |
| Shielding | shield connected to screw connection | |
| Degree of protection | IP68 / IP69 | |
| Cable | according to IEC/EN 60228 (DIN VDE 0295) class 6 | |
| Sheath diameter | 6 mm | |
| Bending radius | > 10 x cable diameter, moving > 5 x cable diameter, fixed | |
| Sheath stripping force | max. 80 N / 300 mm | |
| Sheath color | black (similar to RAL 7021) | |
| Number of cores | 4 | |
| Core cross section | 0.5 mm ² | |
| Cores color | Core 1: brown Core 2: white Core 3: blue Core 4: black | |
| Core construction | 28 x 0.15 mm Ø | |
| Shield | tinned copper braiding, 85 % coverage | |
| Length | L | 0.8 m |
| Cable code | Li 9Y C11Y 4 x 0,50 | |
| Material | | |
| Halogen-free | yes | |
| Plug connector | | |
| Screw connection | Zinc diecast, nickel-plated | |
| Body | TPU, black | |
| Seal | FKM | |
| Contact surface | gold plated (Au) | |
| Flammability | V-2 | |
| Cable | | |
| Sheathing | PUR based on polyether | |
| Core insulation | PP | |
| UV resistance | yes | |
| Microbial resistance | yes | |
| Hydrolysis resistance | yes | |
| Flammability | FT2 | |

Release date: 2023-07-13 Date of issue: 2023-07-13 Filename: 297877_eng.pdf

Connection



Accessories

| | | |
|---|------------------------------|--|
|  | MH V1-SCREWDRIVER | Torque screwdriver (0.6 Nm) |
|  | MH V1-BIT M12 | plug-in cap M12 |
|  | V1/V3-LABELHOLDER | Label holder |
|  | V1/V3-LABEL | Label plate |
|  | MH V1-Holder | Modular universal holder for M12 connectors |
|  | V1-CLIP | Unlocking protector for M12 connector |
|  | V1-MARKING-RING-COLOR | Marking rings for M12 connectors, various colors |