

# Inductive sensor

## NBN4-F25-E8-0,14M



- Direct mounting on standard actuators
- Small construction with sturdy plastic housing of protection class IP 67
- LED for power on



### Dimensions

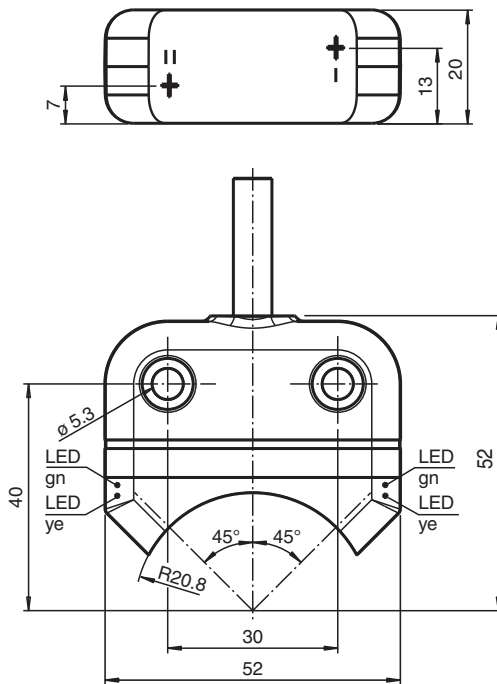

### Technical Data

#### General specifications

Switching function		2 x normally open (NO)
Output type		PNP
Rated operating distance	$s_n$	4 mm
Installation		flush mountable
Output polarity		DC
Assured operating distance	$s_a$	0 ... 3.24 mm
Actual operating distance	$s_r$	3.6 ... 4.4 mm typ.
Reduction factor $r_{AI}$		0.5
Reduction factor $r_{Cu}$		0.4

Release date: 2022-06-30 Date of issue: 2022-06-30 Filename: 305665\_eng.pdf

Refer to "General Notes Relating to Pepperl+Fuchs Product Information".

Pepperl+Fuchs Group  
www.pepperl-fuchs.com

USA: +1 330 486 0001  
fa-info@us.pepperl-fuchs.com

Germany: +49 621 776 1111  
fa-info@de.pepperl-fuchs.com

Singapore: +65 6779 9091  
fa-info@sg.pepperl-fuchs.com

**PF** PEPPERL+FUCHS



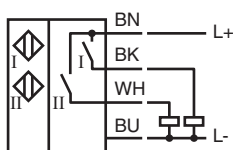

## Technical Data

Reduction factor $r_{304}$		1
Reduction factor $r_{317}$		1.1
Output type		3-wire
<b>Nominal ratings</b>		
Operating voltage	$U_B$	10 ... 30 V DC
Switching frequency	$f$	0 ... 1000 Hz
Hysteresis	$H$	typ. 5 %
Reverse polarity protection		reverse polarity protected
Short-circuit protection		pulsing
Voltage drop	$U_d$	$\leq 2.5$ V
Operating current	$I_L$	0 ... 200 mA
Off-state current	$I_r$	0 ... 0.5 mA typ. 0.1 $\mu$ A at 25 °C
No-load supply current	$I_0$	$\leq 22.5$ mA
Time delay before availability	$t_v$	$\leq 100$ ms
Operating voltage indicator		LED, green
Switching state indicator		LED, yellow
<b>Functional safety related parameters</b>		
MTTF <sub>d</sub>		860 a
Mission Time ( $T_M$ )		20 a
Diagnostic Coverage (DC)		0 %
<b>Compliance with standards and directives</b>		
Standard conformity		
Standards		EN 60947-5-2:2007 EN 60947-5-2/A1:2012 IEC 60947-5-2:2007 IEC 60947-5-2 AMD 1:2012
<b>Approvals and certificates</b>		
UL approval		cULus Listed
CCC approval		CCC approval / marking not required for products rated $\leq 36$ V
<b>Ambient conditions</b>		
Ambient temperature		-25 ... 70 °C (-13 ... 158 °F)
Storage temperature		-40 ... 85 °C (-40 ... 185 °F)
<b>Mechanical specifications</b>		
Connection type		cable PVC , 180 mm
Core cross section		0.14 mm <sup>2</sup>
Housing material		PBT
Sensing face		PC
Degree of protection		IP67
Cable		
Cable diameter		3 mm + 0.3 mm
Bending radius		> 10 x cable diameter
Mass		405 g
Tightening torque, fastening screws		M5 x 25 : 2.7 Nm
Note		Mounted on mechanical drive

## Connection



## Accessories

	<b>BT32</b>	Activator for F25 series
	<b>BT33</b>	Activator for F25 series
	<b>BT34</b>	Activator for F25 series
	<b>BT32XAS</b>	Activator for F25 series
	<b>BT43-RG-01</b>	Activator for F25 series including protective housing and mounting plate