



Laser retroreflective sensor

OBR1500-R3F-E1-0,2M-V31-L



- Very flat design for direct mounting without mounting bracket
- DuraBeam Laser Sensors - durable and employable like an LED
- Glare protected with polarization filter
- Very bright, highly visible light spot

Retroreflective sensor with polarization filter



Dimensions

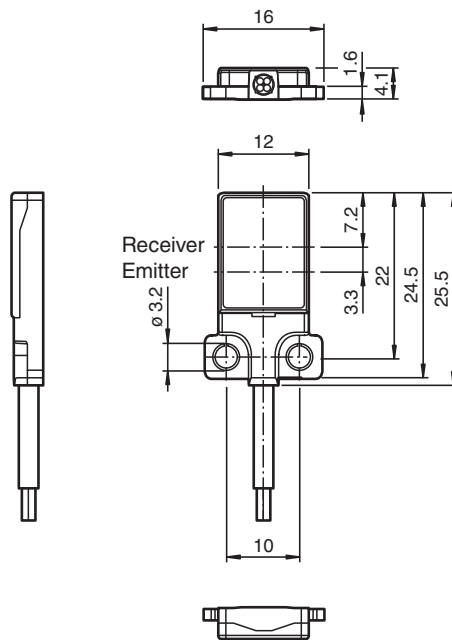

Technical Data

General specifications

Effective detection range	0 ... 1500 mm
Reflector distance	60 ... 1500 mm
Threshold detection range	1800 mm
Reference target	H40 reflector
Light source	LASER LIGHT
Light type	modulated visible red light , 680 nm
Polarization filter	yes
Laser nominal ratings	
Note	LASER LIGHT , DO NOT STARE INTO BEAM

Release date: 2023-03-28 Date of issue: 2023-03-28 Filename: 311820_eng.pdf

Refer to "General Notes Relating to Pepperl+Fuchs Product Information".

Pepperl+Fuchs Group
www.pepperl-fuchs.com

USA: +1 330 486 0001
fa-info@us.pepperl-fuchs.com

Germany: +49 621 776 1111
fa-info@de.pepperl-fuchs.com

Singapore: +65 6779 9091
fa-info@sg.pepperl-fuchs.com

PEPPERL+FUCHS

Technical Data

Laser class		1
Wave length		680 nm
Beam divergence		> 5 mrad
Pulse length		approx. 3 µs
Repetition rate		approx. 16.6 kHz
max. pulse energy		8 nJ
Angle deviation		approx. 0.5 °
Object size		typ. starts from 1.5 mm
Diameter of the light spot		approx. 25 mm at a distance of 1500 mm
Opening angle		approx. 1 °
Optical face		frontal
Ambient light limit		EN 60947-5-2 : 30000 Lux
Functional safety related parameters		
MTTF _d		800 a
Mission Time (T _M)		20 a
Diagnostic Coverage (DC)		0 %
Indicators/operating means		
Operation indicator		LED green, statically lit Power on , short-circuit : LED green flashing (approx. 4 Hz)
Function indicator		Receiver: LED yellow, lights up when light beam is free, flashes when falling short of the operating reserve ; OFF when light beam is interrupted
Electrical specifications		
Operating voltage	U _B	12 ... 24 V
No-load supply current	I ₀	< 10 mA
Protection class		III
Output		
Switching type		NC contact / light-on
Signal output		1 NPN output, short-circuit protected, reverse polarity protected, open collector
Switching voltage		max. 30 V DC
Switching current		max. 50 mA , resistive load
Voltage drop	U _d	≤ 1.5 V DC
Switching frequency	f	approx. 2 kHz
Response time		250 µs
Conformity		
Product standard		EN 60947-5-2
Laser safety		EN 60825-1:2007
Approvals and certificates		
UL approval		E87056 , cULus Recognized, Class 2 Power Source
CCC approval		CCC approval / marking not required for products rated ≤36 V
FDA approval		IEC 60825-1:2007 Complies with 21 CFR 1040.10 and 1040.11 except for deviations pursuant to Laser Notice No. 50, dated June 24, 2007
Ambient conditions		
Ambient temperature		-10 ... 60 °C (14 ... 140 °F)
Storage temperature		-20 ... 70 °C (-4 ... 158 °F)
Mechanical specifications		
Housing width		16 mm
Housing height		25.5 mm
Housing depth		4.1 mm
Degree of protection		IP67
Connection		200 mm fixed cable with 4-pin, M8x1 connector
Material		
Housing		PC (Polycarbonate) and Stainless steel
Optical face		PMMA
Cable		PUR
Mass		approx. 10 g

Release date: 2023-03-28 Date of issue: 2023-03-28 Filename: 311820_eng.pdf

Refer to "General Notes Relating to Pepperl+Fuchs Product Information".

Pepperl+Fuchs Group
www.pepperl-fuchs.comUSA: +1 330 486 0001
fa-info@us.pepperl-fuchs.comGermany: +49 621 776 1111
fa-info@de.pepperl-fuchs.comSingapore: +65 6779 9091
fa-info@sg.pepperl-fuchs.com

PEPPERL+FUCHS

Technical Data

Tightening torque, fastening screws	1 Nm
Cable length	200 mm

Connection

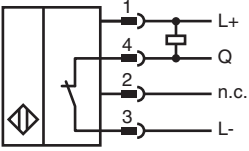

Connection Assignment



Wire colors in accordance with EN 60947-5-2

- | | | |
|---|----|---------|
| 1 | BN | (brown) |
| 2 | WH | (white) |
| 3 | BU | (blue) |
| 4 | BK | (black) |

Characteristic Curve

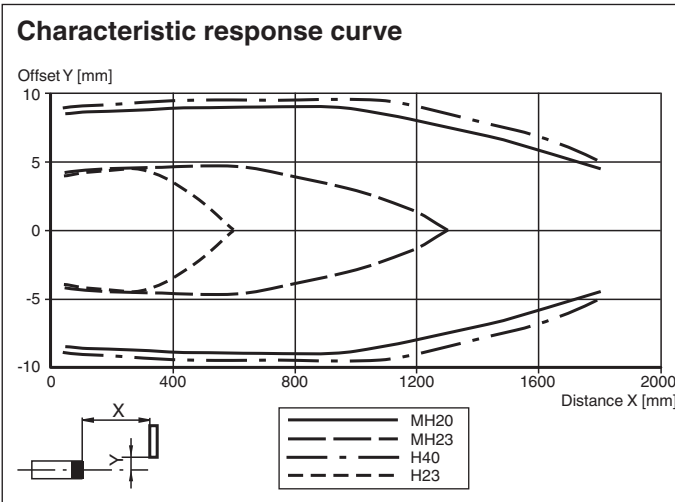

Release date: 2023-03-28 Date of issue: 2023-03-28 Filename: 311820_eng.pdf

Refer to "General Notes Relating to Pepperl+Fuchs Product Information".

Characteristic Curve

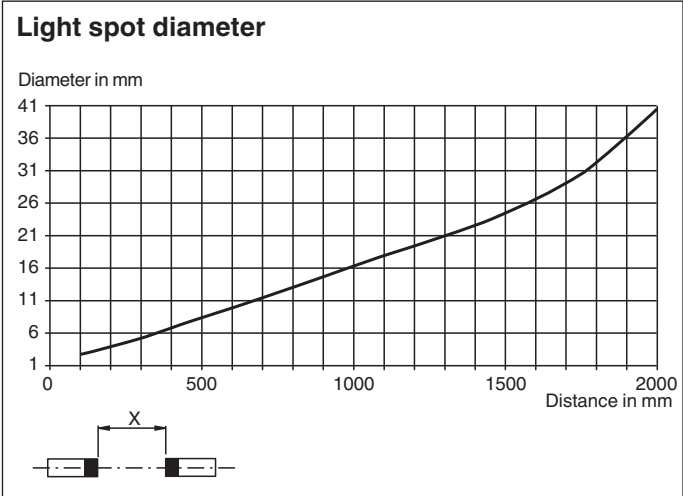
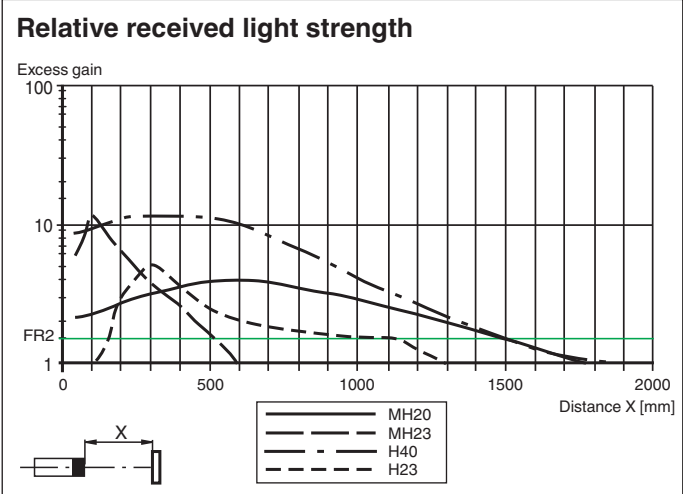

Safety Information



Release date: 2023-03-28 Date of issue: 2023-03-28 Filename: 311820_eng.pdf

Refer to "General Notes Relating to Pepperl+Fuchs Product Information".

Pepperl+Fuchs Group
www.pepperl-fuchs.com

USA: +1 330 486 0001
fa-info@us.pepperl-fuchs.com

Germany: +49 621 776 1111
fa-info@de.pepperl-fuchs.com

Singapore: +65 6779 9091
fa-info@sg.pepperl-fuchs.com



Safety Information

Laser Class 1 Information

The irradiation can lead to irritation especially in a dark environment. Do not point at people!







Maintenance and repairs should only be carried out by authorized service personnel!

Attach the device so that the warning is clearly visible and readable.

The warning accompanies the device and should be attached in immediate proximity to the device.

Caution – Use of controls or adjustments or performance of procedures other than those specified herein may result in hazardous radiation exposure.

Accessories

	REF-H40	Reflector, rectangular 47.5 mm x 23.5 mm, mounting holes, fixing strap
	REF-H23	Reflector with mounting holes
	REF-MH20	Reflector with Micro-structure, rectangular 32 mm x 20 mm, mounting holes
	REF-MH23	Reflector with Micro-structure, rectangular 23 mm x 13.8 mm, diagonal mounting hole
	V31-GM-2M-PUR	Female cordset single-ended M8 straight A-coded, 4-pin, PUR cable grey
	V31-WM-2M-PUR	Female cordset single-ended M8 angled A-coded, 4-pin, PUR cable grey