

Locknuts

LN.M32.BN.K50

- Brass nickel-plated
- Thread M32
- Packaging unit: 50 pieces

Dimensions

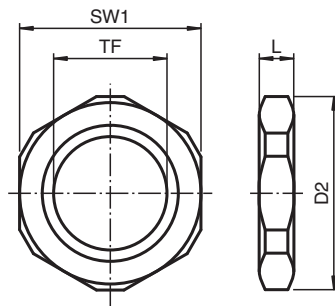

Dimension values see data table.
Image and drawing are generic for this component type and may deviate from the specific variant.

Legend	
D2	Width across corners
L	Total length
SW1	Width across flats
TF	Thread size female

Technical Data

Mechanical specifications	
Thread type	metric ISO pitch 1.5 mm
Thread size female (TF)	M32
Material	brass, nickel-plated
Finish	inherent color silver
Dimensions	
Width across corners (D2)	39.5 mm

Release date: 2020-06-02 Date of issue: 2020-06-02 Filename: 312478_eng.pdf

Refer to "General Notes Relating to Pepperl+Fuchs Product Information".

Pepperl+Fuchs Group
www.pepperl-fuchs.com

USA: +1 330 486 0002
pa-info@us.pepperl-fuchs.com

Germany: +49 621 776 2222
pa-info@de.pepperl-fuchs.com

















Singapore: +65 6779 9091
pa-info@sg.pepperl-fuchs.com

 PEPPERL+FUCHS

Technical Data

Width across flats (SW1)	36 mm
Total length (L)	5 mm
General information	
Delivery quantity	50
Scope of delivery	Locknuts

Matching system components

	CG.AR.M32L.SS. C.16.K10
	CG.AR.M32.SS.C.16.K10
	CG.AR.M32L.BN. C.16.K10
	CG.AR.M32.BN.C.16.K10
	CG.CO.M32.BN.C.16.K10
	CG.EM.M32.BN.C.19.K15
	CG.EM.M32.SS.C.19.K15
	CG.NA.M32S.BN. C.16.K15
	CG.NA.M32S.SS. C.16.K15
	AD.M32.M20.BN. C.15.K35
	AD.M32.M25.BN. C.15.K35
	AD.M32.NPT1.BN. C.15.K35
	AD.M32.NPT1.SS. C.15.K35
	AD.M32.NPT3/4.BN. C.15.K35
	AD.M32.NPT3/4.SS. C.15.K35
	SP.MD.M32.BN.C.15.K25
	SP.MD.M32.SS.C.15.K25

Release date: 2020-06-02 Date of issue: 2020-06-02 Filename: 312478_eng.pdf

Refer to "General Notes Relating to Pepperl+Fuchs Product Information".

Matching system components



SP.PE.M32.PA.C.15.K20

Release date: 2020-06-02 Date of issue: 2020-06-02 Filename: 312478_eng.pdf

Refer to "General Notes Relating to Pepperl+Fuchs Product Information".

Pepperl+Fuchs Group
www.pepperl-fuchs.com

USA: +1 330 486 0002
pa-info@us.pepperl-fuchs.com

Germany: +49 621 776 2222
pa-info@de.pepperl-fuchs.com

Singapore: +65 6779 9091
pa-info@sg.pepperl-fuchs.com

 **PEPPERL+FUCHS**