

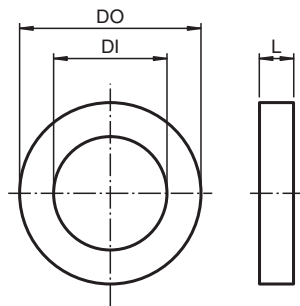

# Flachdichtung WA.FL.M25.F.K100

- Für Gewinde M25
- Verpackungseinheit: 100 Stück

## Abmessungen



Abmessungen siehe Tabelle technische Daten.  
Abbildung und Zeichnung sind allgemeingültig für diesen Komponententyp und können von der spezifischen Variante abweichen.

Legende	
DO	Außendurchmesser
DI	Innendurchmesser
L	Gesamtlänge

## Technische Daten

Mechanische Daten	
Material	Aramidfasern gebunden mit NBR
Finish	Eigenfarbe grün
Abmessungen	
Außendurchmesser (DO)	32,2 mm
Innendurchmesser (DI)	25,1 mm
Gesamtlänge (L)	1,5 mm
Allgemeine Informationen	
Liefermenge	100

Veröffentlichungsdatum: 2020-06-02 Ausgabedatum: 2020-06-02 Dateiname: 312497\_ger.pdf

Beachten Sie „Allgemeine Hinweise zu Pepperl+Fuchs-Produktinformationen“.

Pepperl+Fuchs-Gruppe  
www.pepperl-fuchs.com

USA: +1 330 486 0002  
pa-info@us.pepperl-fuchs.com

Deutschland: +49 621 776 2222  
pa-info@de.pepperl-fuchs.com

Singapur: +65 6779 9091  
pa-info@sg.pepperl-fuchs.com

















**PF** PEPPERL+FUCHS

**Technische Daten**

Lieferumfang

Flachdichtung

**Passende Systemkomponenten**

	<b>CG.AR.M25S.BN. C.16.K10</b>	
	<b>CG.AR.M25S.SS. C.16.K10</b>	
	<b>CG.AR.M25L.BN. C.16.K10</b>	
	<b>CG.AR.M25.SS.C.16.K10</b>	
	<b>CG.AR.M25L.SS. C.16.K10</b>	
	<b>CG.AR.M25.BN.C.16.K10</b>	
	<b>CG.CO.M25.BN.C.16.K10</b>	
	<b>CG.EM.M25.BN.C.16.K25</b>	
	<b>CG.EM.M25.SS.C.16.K25</b>	
	<b>CG.NA.M25.BN.C.16.K15</b>	
	<b>CG.NA.M25S.BN. C.16.K25</b>	
	<b>CG.NA.M25.SS.C.16.K15</b>	
	<b>CG.NA.M25S.SS. C.16.K25</b>	
	<b>AD.M25.M20.BN. C.15.K35</b>	
	<b>AD.M25.NPT1.BN. C.15.K35</b>	
	<b>AD.M25.NPT1.SS. C.15.K35</b>	
	<b>AD.M25.NPT1/2.BN. C.15.K35</b>	
	<b>AD.M25.NPT1/2.SS. C.15.K35</b>	
	<b>AD.M25.NPT3/4.BN. C.15.K35</b>	

Veröffentlichungsdatum: 2020-06-02 Ausgabedatum: 2020-06-02 Dateiname: 312497\_ger.pdf

Beachten Sie „Allgemeine Hinweise zu Pepperl+Fuchs-Produktinformationen“.

Pepperl+Fuchs-Gruppe  
www.pepperl-fuchs.com

USA: +1 330 486 0002  
pa-info@us.pepperl-fuchs.com

Deutschland: +49 621 776 2222  
pa-info@de.pepperl-fuchs.com

Singapur: +65 6779 9091  
pa-info@sg.pepperl-fuchs.com

**Passende Systemkomponenten**



**AD.M25.NPT3/4.SS.  
C.15.K35**



**SP.MD.M25.BN.C.15.K50**



**SP.MD.M25.SS.C.15.K50**

Veröffentlichungsdatum: 2020-06-02 Ausgabedatum: 2020-06-02 Dateiname: 312497\_ger.pdf

Beachten Sie „Allgemeine Hinweise zu Pepperl+Fuchs-Produktinformationen“.

Pepperl+Fuchs-Gruppe  
www.pepperl-fuchs.com

USA: +1 330 486 0002  
pa-info@us.pepperl-fuchs.com

Deutschland: +49 621 776 2222  
pa-info@de.pepperl-fuchs.com

Singapur: +65 6779 9091  
pa-info@sg.pepperl-fuchs.com