



washer gasket

WA.FL.M32.F.K100

- For thread M32
- Packaging unit: 100 pieces

Dimensions

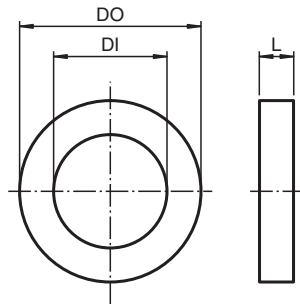

Dimension values see data table.
Image and drawing are generic for this component type and may deviate from the specific variant.

Legend	
DO	Outer diameter
DI	Inside diameter
L	Total length

Technical Data

Mechanical specifications

Material	aramid fibers bonded with NBR
Finish	inherent color green
Dimensions	
Outer diameter (DO)	39.8 mm
Inside diameter (DI)	32.1 mm
Total length (L)	1.5 mm
General information	
Delivery quantity	100

Release date: 2020-06-02 Date of issue: 2020-06-02 Filename: 312498_eng.pdf

Refer to "General Notes Relating to Pepperl+Fuchs Product Information".

Pepperl+Fuchs Group
www.pepperl-fuchs.com

USA: +1 330 486 0002
pa-info@us.pepperl-fuchs.com

Germany: +49 621 776 2222
pa-info@de.pepperl-fuchs.com

















Singapore: +65 6779 9091
pa-info@sg.pepperl-fuchs.com

PF PEPPERL+FUCHS

Technical Data

Scope of delivery	washer gasket
-------------------	---------------

Matching system components

	CG.AR.M32L.BN. C.16.K10
	CG.AR.M32L.SS. C.16.K10
	CG.AR.M32.SS.C.16.K10
	CG.AR.M32.BN.C.16.K10
	CG.CO.M32.BN.C.16.K10
	CG.EM.M32.BN.C.19.K15
	CG.EM.M32.SS.C.19.K15
	CG.NA.M32S.BN. C.16.K15
	CG.NA.M32S.SS. C.16.K15
	AD.M32.M20.BN. C.15.K35
	AD.M32.M25.BN. C.15.K35
	AD.M32.NPT1.BN. C.15.K35
	AD.M32.NPT1.SS. C.15.K35
	AD.M32.NPT3/4.BN. C.15.K35
	AD.M32.NPT3/4.SS. C.15.K35
	SP.MD.M32.BN.C.15.K25
	SP.MD.M32.SS.C.15.K25

Release date: 2020-06-02 Date of issue: 2020-06-02 Filename: 312498_eng.pdf