

washer gasket

WA.FL.M40.F.K50

- For thread M40
- Packaging unit: 50 pieces

Dimensions

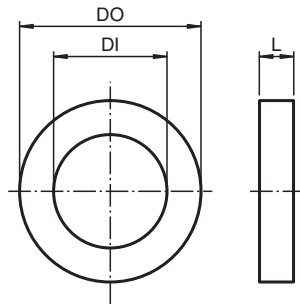

Dimension values see data table.
Image and drawing are generic for this component type and may deviate from the specific variant.

Legend	
DO	Outer diameter
DI	Inside diameter
L	Total length

Technical Data

Mechanical specifications

Material	aramid fibers bonded with NBR
Finish	inherent color green
Dimensions	
Outer diameter (DO)	49.6 mm
Inside diameter (DI)	40.1 mm
Total length (L)	1.5 mm
General information	
Delivery quantity	50

Release date: 2020-06-02 Date of issue: 2020-06-02 Filename: 312499_eng.pdf

Refer to "General Notes Relating to Pepperl+Fuchs Product Information".

Pepperl+Fuchs Group
www.pepperl-fuchs.com

USA: +1 330 486 0002
pa-info@us.pepperl-fuchs.com

Germany: +49 621 776 2222
pa-info@de.pepperl-fuchs.com















Singapore: +65 6779 9091
pa-info@sg.pepperl-fuchs.com

pf PEPPERL+FUCHS

Technical Data

Scope of delivery washer gasket

Matching system components

	CG.AR.M40.SS.C.16.K10
	CG.AR.M40.BN.C.16.K05
	CG.CO.M40.BN.C.18.K05
	CG.EM.M40.BN.C.20.K05
	CG.EM.M40.SS.C.20.K05
	CG.NA.M40S.BN.C.18.K05
	CG.NA.M40S.SS.C.18.K05
	AD.M40.M32.BN.C.18.K20
	AD.M40.NPT1-1/2.BN.C.18.K20
	AD.M40.NPT1-1/2.SS.C.18.K20
	AD.M40.NPT1-1/4.BN.C.18.K20
	AD.M40.NPT1-1/4.SS.C.18.K20
	SP.MD.M40.BN.C.17.K10
	SP.MD.M40.SS.C.17.K10

Release date: 2020-06-02 Date of issue: 2020-06-02 Filename: 312499_eng.pdf