

Cable connector, NAMUR

V1-WV4A-N-30M-PVC

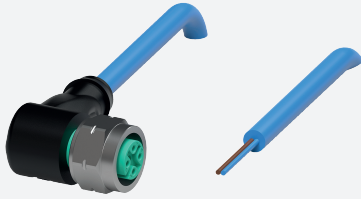

- Suitable for NAMUR technology
- Screw connection stainless steel
- Degree of protection IP68 / IP69
- Suitable for routing intrinsically safe circuits in accordance with DIN EN 60079-14:2014
- Specific design protects against loosening and inaccurate installation

Female cordset single-ended M12 angled stainless steel 1.4404, A-coded, 2-pin, PVC cable blue, NAMUR



Dimensions

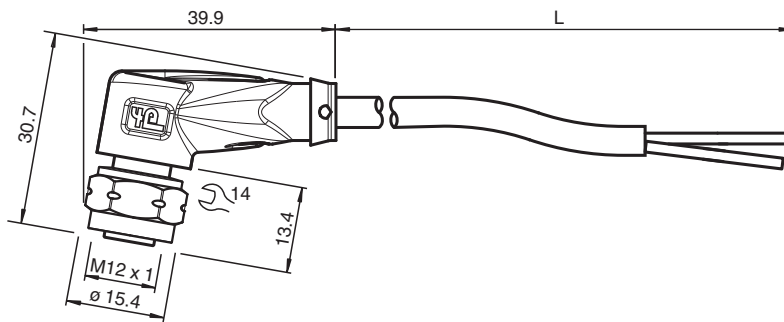

Technical Data

General specifications

Connector 1	
Connection	socket
Construction type	M12
Style	angled
Locking	screw connection
Number of pins	2
Coding	A-coded
Connector 2	
Connection	cable end

Electrical specifications

Operating voltage	U_B	max. 250 V AC/DC
Operating current	I_B	4 A
Resistance per unit length	R'	max. 0.053 Ω /m
Capacitance per unit length	C'	101.8 nF/km
Inductance per unit length	L'	0.581 mH/km

Conformity

Degree of protection	EN 60529
Plug connection	connector M12 x 1 : IEC 61076-2-101

Ambient conditions

Ambient temperature	
---------------------	--

Release date: 2023-09-04 Date of issue: 2023-09-04 Filename: 325008_eng.pdf

Refer to "General Notes Relating to Pepperl+Fuchs Product Information".

Pepperl+Fuchs Group
www.pepperl-fuchs.com

USA: +1 330 486 0001
fa-info@us.pepperl-fuchs.com

Germany: +49 621 776 1111
fa-info@de.pepperl-fuchs.com

Singapore: +65 6779 9091
fa-info@sg.pepperl-fuchs.com

PEPPERL+FUCHS



Technical Data

Plug connector		-40 ... 90 °C (-40 ... 194 °F)
Cable, fixed		-25 ... 70 °C (-13 ... 158 °F)
Cable, flexing		-5 ... 70 °C (23 ... 158 °F)
Pollution degree		3
Mechanical specifications		
Plug connector		
Tightening torque		0.6 Nm
Tool installation		hexagon nut SW = 14 mm
Mating cycles		min. 100
Degree of protection		IP68 / IP69
Cable		according to IEC/EN 60228 (DIN VDE 0295) class 5
Sheath diameter		4.8 mm
Bending radius		> 10 x cable diameter, fixed > 15 x cable diameter, moving
Sheath color		blue (similar to RAL 5015)
Number of cores		2
Core cross section		0.34 mm ²
Cores color		Core 1: brown Core 2: blue
Core construction		19 x 0.15 mm Ø
Length	L	30 m
Cable code		Li YY 2 x 0,34
Material		
Plug connector		
Screw connection		Stainless steel 1.4404 / AISI 316L
Body		TPU, black
Seal		FKM
Contact surface		gold plated (Au)
Flammability		V-2
Cable		
Sheathing		PVC
Core insulation		PVC

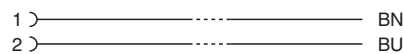



Connection



Accessories

	MH V1-SCREWDRIVER	Torque screwdriver (0.6 Nm)
	MH V1-BIT M12-W14-HEX	Plug-in attachment for M12 with hex stainless steel knurled nut
	V1/V3-LABELHOLDER	Label holder

Accessories

	V1/V3-LABEL	Label plate
	MH V1-Holder	Modular universal holder for M12 connectors
	V1-CLIP	Unlocking protector for M12 connector
	V1-MARKING-RING-COLOR	Marking rings for M12 connectors, various colors