

NPT to metric coupler

6000-COUPLER-3/4-M20



- Converts 3/4" NPT male thread to M20 female thread
- Exd, Exe fittings
- Easy to add on any certified cable gland

Function

The 6000-COUPLER, female to female adapter, is designed to convert the 3/4" NPT male power conduit of the purge 6000 Series control unit to a female metric size thread so that standard certified cable glands can be used.

Dimensions

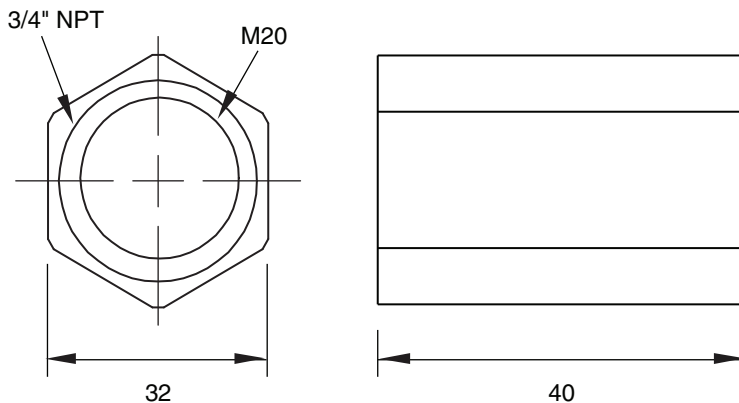

Technical Data

Ambient conditions	
Ambient temperature	-60 ... 200 °C (-76 ... 392 °F)
Mechanical specifications	
Degree of protection	IP64
Material	brass, nickel-plated
Dimensions	40 mm long x 32 mm across the flats
Data for application in connection with hazardous areas	
EC-Type Examination Certificate	Sira 10ATEX1225X Sira 00ATEX1073U IECEX SIR 09.084U GOST TC C-GB.06.B00105 INMETRO NCC 12.0764U
Group, category, type of protection	Exd I&Ic / Exe I&I / Ex tD A21

Release date: 2021-01-08 Date of issue: 2021-01-08 Filename: 514474_eng.pdf

Refer to "General Notes Relating to Pepperl+Fuchs Product Information".

Pepperl+Fuchs Group
www.pepperl-fuchs.com

USA: +1 330 486 0002
pa-info@us.pepperl-fuchs.com

Germany: +49 621 776 2222
pa-info@de.pepperl-fuchs.com

Singapore: +65 6779 9091
pa-info@sg.pepperl-fuchs.com

PF PEPPERL+FUCHS