



Remote Monitor Workstation RM919 Series

- 19 inch TFT display w/ optional touch screen
- Seams continuously welded and ground smooth (Type 4/4X, IP66)
- Various keyboard/mouse options
- Video transfer via EtherNet/IP connection
- 100 mm VESA mount
- Class I, Div. 2 / ATEX Zone 2 approved

19 inch remote monitor



Function

The RM919 remote monitor is designed for continuous use in harsh environments such as manufacturing, oil & gas, and chemical applications. The RM transmits video data digitally from the host PC to the monitor over an Ethernet connection using RDP, VNC, or ICA protocol. The compact housing design allows for easy mounting using the industry standard 100 mm VESA mount. This 19" monitor features an optional touchscreen and keyboard with various mouse options.

Connection

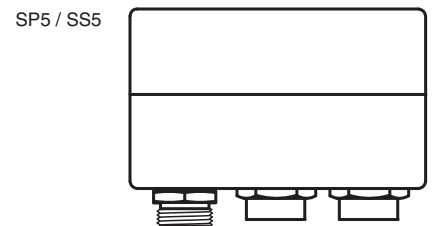
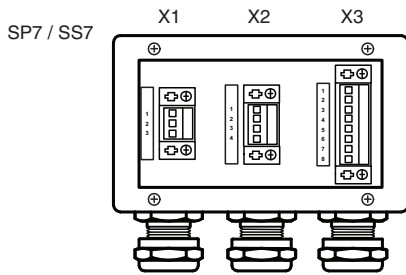

X1 Terminals	AC	DC
1.1	L	+
1.2	N	-
1.3	GND	GND

X2 Terminals	Description
2.1	VCC RD
2.2	D+ GN
2.3	D- WH
2.4	GND BK

X3 Terminals	Description
3.1	BI_DA + WH/GN
3.2	BI_DA - GN
3.3	BI_DB + WH/OR
3.4	BI_DC + BU
3.5	BI_DC - WH/BU
3.6	BI_DB - OR
3.7	BI_DD + WH/BN
3.8	BI_DD - BN

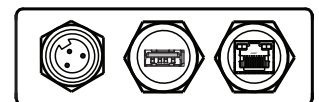

Release date: 2022-02-28 Date of issue: 2022-02-28 Filename: 547089_eng.pdf

Refer to "General Notes Relating to Pepperl+Fuchs Product Information".

Pepperl+Fuchs Group
www.pepperl-fuchs.com

USA: +1 330 486 0002
pa-info@us.pepperl-fuchs.com

Germany: +49 621 776 2222
pa-info@de.pepperl-fuchs.com

Singapore: +65 6779 9091
pa-info@sg.pepperl-fuchs.com

PF PEPPERL+FUCHS

Dimensions

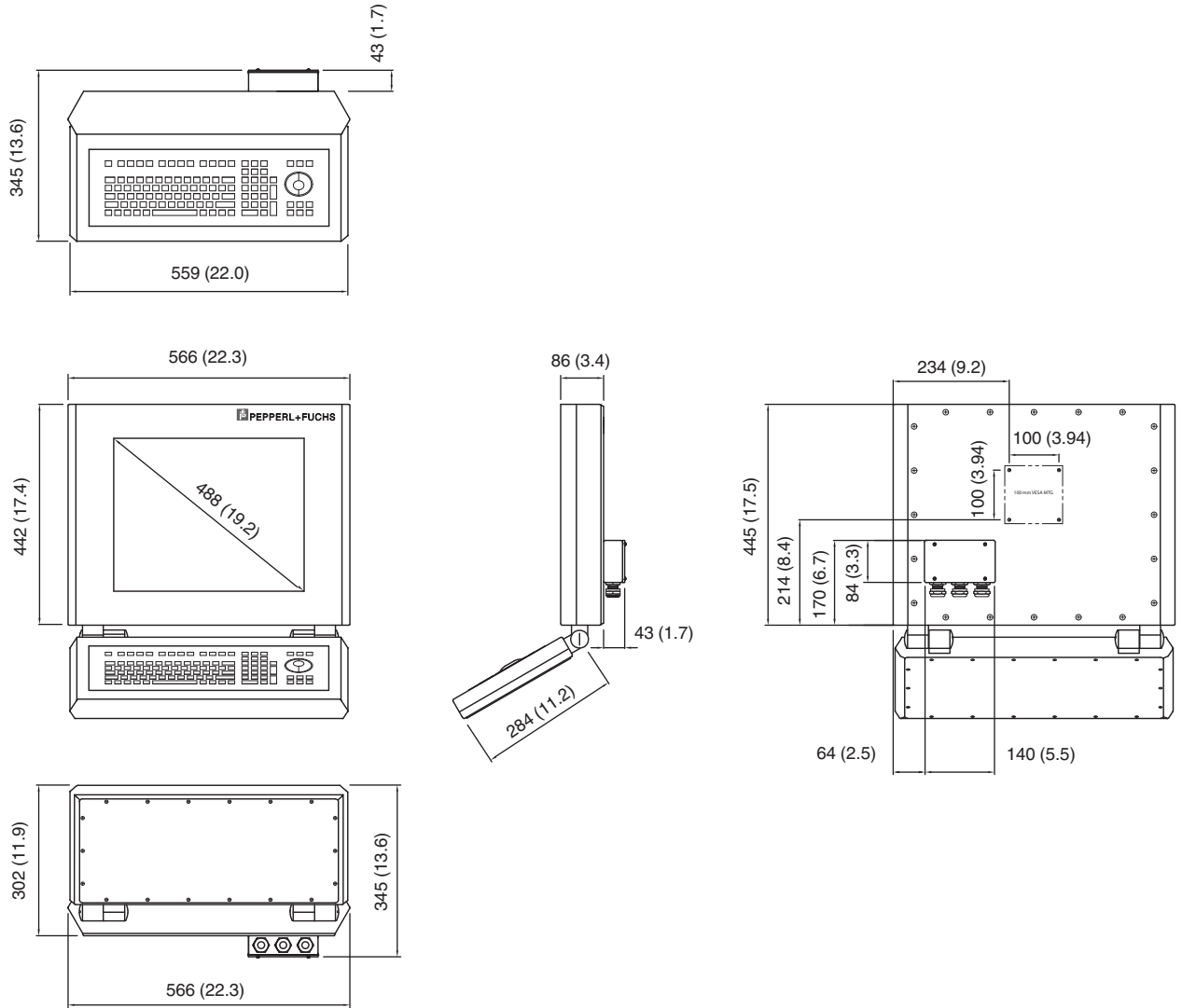

Release date: 2022-02-28 Date of issue: 2022-02-28 Filename: 547089_eng.pdf

Technical Data

Hardware	
Processor	Intel® Atom™ E3826 1.46 GHz alternative: 1.58GHz Intel® Celeron N2807 *
RAM	4 GB
Mass storage	compact flash: 32 GB CFAST
Supply	
Power consumption	60 W max, 100 ... 240 VAC, 50 ... 60 Hz, or 20-30 VDC
Indicators/operating means	
Display	

Refer to "General Notes Relating to Pepperl+Fuchs Product Information".

Technical Data





Screen diagonal	19 inch (483 mm)
Response time	12 ms
Resolution	1280 x 1024
Color depth	24 bit (16.7 M) color
Contrast	1000:1
Brightness	450 cd/m ² (nit)
Reading angle	160° in all directions
Life span	back lamp life: 50,000 hrs typical half life
Input devices	
Touchscreen	5-wire resistive 5-wire hardened resistive
Keyboard	touchpad , optical trackball (50 mm) , joystick connections : USB
Interface	
Interface type	1 x RJ-45 (GB ethernet) , 1 x USB 2.0 , 1 x power 1 x Fiber optic LAN, SC duplex, multimode (optional)
Directive conformity	
Electromagnetic compatibility	
Directive 89/336/EEC	EN55022A, EN61000-6-2, EN61000-3-2, EN61000-3-3
Software	
Operating system	VisuNet RM Shell 5 (based on Microsoft® Windows® 10 IoT LTSB)
Ambient conditions	
Operating temperature	-20 ... 50 °C (-4 ... 122 °F)
Storage temperature	-20 ... 60 °C (-4 ... 140 °F)
Relative humidity	0 ... 90% (noncondensing)
Shock resistance	30g, 11 ms, all axis
Vibration resistance	5 ... 100 Hz 1G, 12 m/s ²
Mechanical specifications	
Degree of protection	Type 4X (stainless steel) Type 4 (painted steel) IP66
Material	Main enclosure: painted black steel or 316L stainless steel Main enclosure (rear cover): 6062 anodized aluminum, marine grade
Installation	100 mm (3.9 inch) VESA mount
Mass	Main unit: 13.6 kg (30 lb) without keyboard; 19.1 kg (42 lb) with keyboard
Dimensions	Main enclosure: 566 x 442 x 86 mm (22.3 x 17.4 x 3.4 inch), junction box adds 43 mm (1.7 inch) to depth Keyboard enclosure: 559 x 254 x 51 mm (22.0 x 10.0 x 2.0 inch)
Data for application in connection with hazardous areas	
EU-type examination certificate	
Marking	Ⓔ II 3G Ex ic nA IIC T4 Gc
International approvals	
ETL approval	Class I, Div. 2 Groups A, B, C, D; T4
General information	
Supplementary information	* see Typelabel 2021 alternative, processor can not be chosen

Accessories

	VISUNET-RM-SHELL5 (2019 LTSC)	Thin Client Firmware for VisuNet Remote Monitors, Box Thin Clients and Tablet Thin Clients (mobile)
	VISUNET-RM-SHELL5 (2016 LTSC)	Thin Client Firmware for VisuNet Remote Monitors and Box Thin Clients
	VISUNET-CONTROL-CENTER	Additional Management tool for VisuNet Remote Monitors and Box Thin Clients

Refer to "General Notes Relating to Pepperl+Fuchs Product Information".

Accessories

	VISUNET-RM-SHELL5-CC	VisuNet Control Center License Key for RM Shell 5
	VISUNET-RM-SHELL5-DRDC	DRDC License Key for RM Shell 5
	VISUNET-RM-SHELL5-PRO	PRO License Key for RM Shell 5
	VESA CABLE FEEDTHROUGH	Slimline adapter plate
	SL-2ES-2SC	Industrial Ethernet Media Converter

Release date: 2022-02-28 Date of issue: 2022-02-28 Filename: 547089_eng.pdf

Refer to "General Notes Relating to Pepperl+Fuchs Product Information".

Pepperl+Fuchs Group
www.pepperl-fuchs.com

USA: +1 330 486 0002
pa-info@us.pepperl-fuchs.com

Germany: +49 621 776 2222
pa-info@de.pepperl-fuchs.com

Singapore: +65 6779 9091
pa-info@sg.pepperl-fuchs.com

Type Code

R M 9 1 9 A - D 2 - T 51 A C - S P 5 C K 0 L 0 - S 0 - N

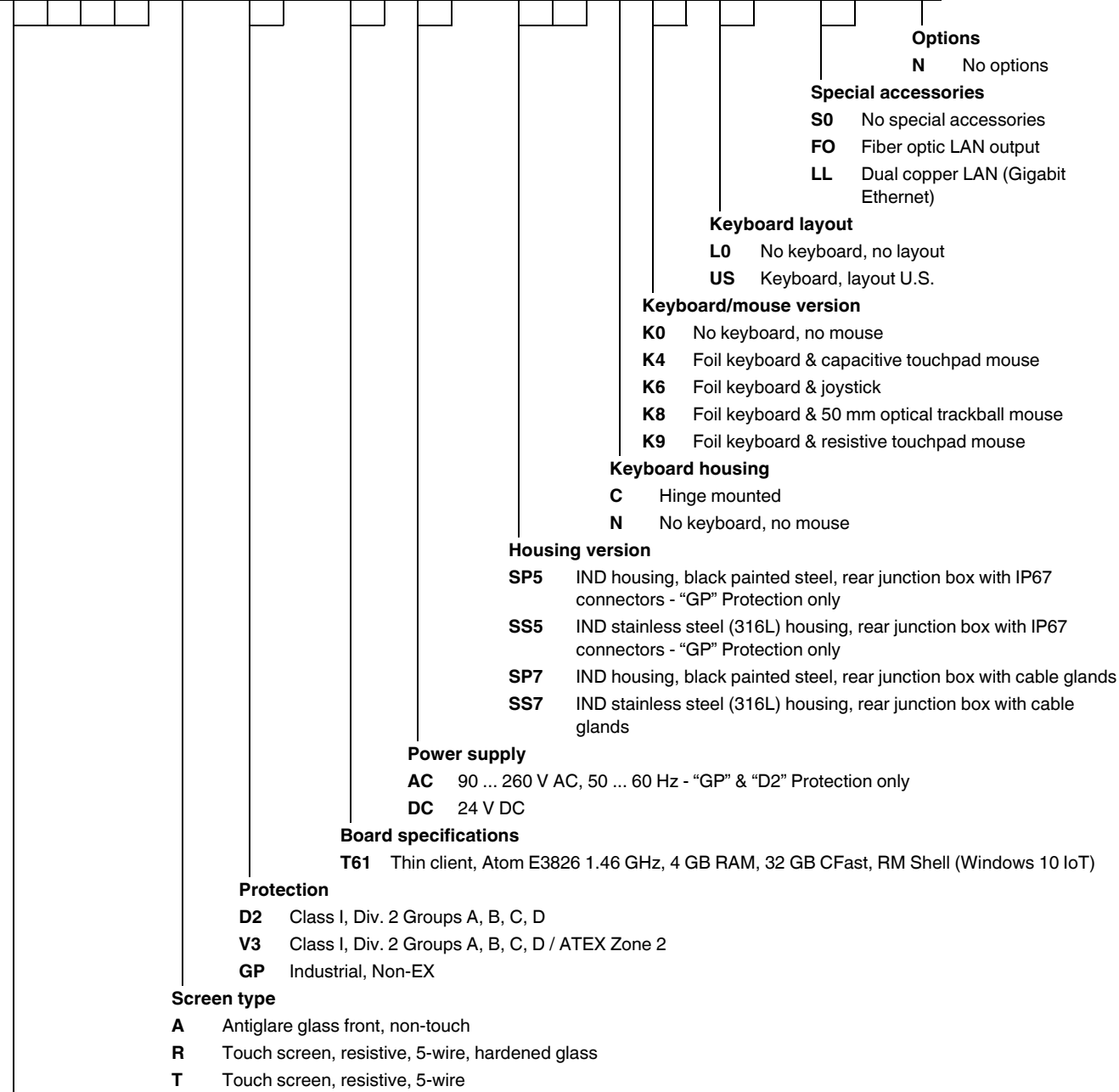

Options

N No options

Special accessories

S0 No special accessories

FO Fiber optic LAN output

LL Dual copper LAN (Gigabit Ethernet)

Keyboard layout

L0 No keyboard, no layout

US Keyboard, layout U.S.

Keyboard/mouse version

K0 No keyboard, no mouse

K4 Foil keyboard & capacitive touchpad mouse

K6 Foil keyboard & joystick

K8 Foil keyboard & 50 mm optical trackball mouse

K9 Foil keyboard & resistive touchpad mouse

Keyboard housing

C Hinge mounted

N No keyboard, no mouse

Housing version

SP5 IND housing, black painted steel, rear junction box with IP67 connectors - "GP" Protection only

SS5 IND stainless steel (316L) housing, rear junction box with IP67 connectors - "GP" Protection only

SP7 IND housing, black painted steel, rear junction box with cable glands

SS7 IND stainless steel (316L) housing, rear junction box with cable glands

Power supply

AC 90 ... 260 V AC, 50 ... 60 Hz - "GP" & "D2" Protection only

DC 24 V DC

Board specifications

T61 Thin client, Atom E3826 1.46 GHz, 4 GB RAM, 32 GB CFAST, RM Shell (Windows 10 IoT)

Protection

D2 Class I, Div. 2 Groups A, B, C, D

V3 Class I, Div. 2 Groups A, B, C, D / ATEX Zone 2

GP Industrial, Non-EX

Screen type

A Antiglare glass front, non-touch

R Touch screen, resistive, 5-wire, hardened glass

T Touch screen, resistive, 5-wire

RM919 Remote monitor, 19 in (483 mm), SXGA (1280 x 1024 pixels), Ethernet Network connection, RDP, TCP/IP

Release date: 2022-02-28 Date of issue: 2022-02-28 Filename: 547089_eng.pdf

Release date: 2022-02-28 Date of issue: 2022-02-28 Filename: 547089_eng.pdf

Refer to "General Notes Relating to Pepperl+Fuchs Product Information".

Pepperl+Fuchs Group
www.pepperl-fuchs.com

USA: +1 330 486 0002
pa-info@us.pepperl-fuchs.com

Germany: +49 621 776 2222
pa-info@de.pepperl-fuchs.com

Singapore: +65 6779 9091
pa-info@sg.pepperl-fuchs.com

