



Optical reader - safePXV

PXV100AQ-F200-B28-V1D

- SIL 3 (EN 61508)
- Category 4 PL e (EN ISO 13849)
- PROFINET interface
- PROFIsafe interface
- Safe, non-contact positioning on Data Matrix code tape
- Traverse distance up to 100 km
- Mechanically rugged: no wearing parts, long operating life, maintenance-free
- Output of code quality
- Pollution detection

Read head for incident light positioning system



Dimensions

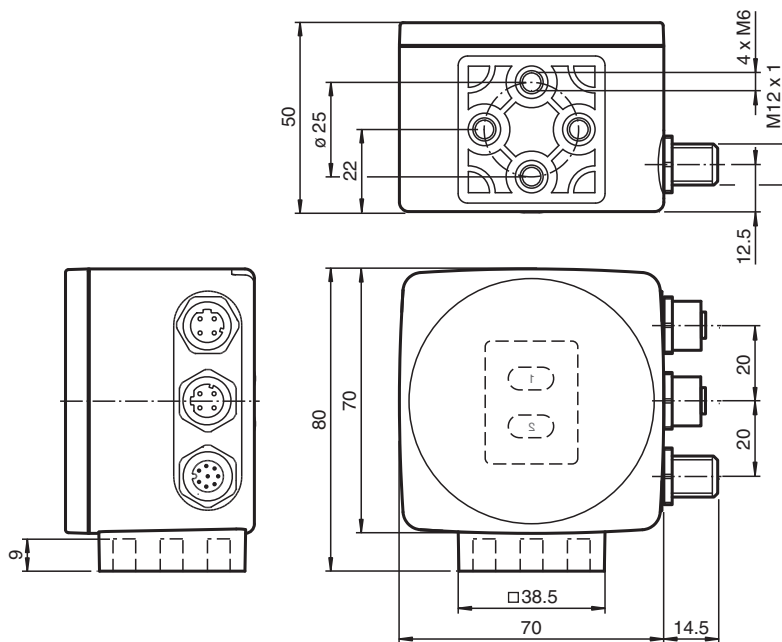

Technical Data

General specifications

Passage speed	v	≤ 8 m/s
Measuring range		max. 100000 m
Light type		Integrated LED lightning (red/blue)
Read distance		100 mm
Depth of focus		± 30 mm
Field of view		typ. 120 mm x 80 mm
Ambient light limit		30000 Lux
Accuracy		
Non safety-related X		± 0.2 mm

Release date: 2023-07-07 Date of issue: 2023-07-07 Filename: 70105248_eng.pdf

Refer to "General Notes Relating to Pepperl+Fuchs Product Information".

Pepperl+Fuchs Group
www.pepperl-fuchs.com

USA: +1 330 486 0001
fa-info@us.pepperl-fuchs.com

Germany: +49 621 776 1111
fa-info@de.pepperl-fuchs.com

Singapore: +65 6779 9091
fa-info@sg.pepperl-fuchs.com

PF PEPPERL+FUCHS

Technical Data

Safety-related X		See the original instructions
Nominal ratings		
Camera		
Type		CMOS , Global shutter
Processor		
Clock pulse frequency		600 MHz
Speed of computation		4800 MIPS
Functional safety related parameters		
Safety Integrity Level (SIL)		SIL 3
Performance level (PL)		PL e
Category		Cat. 4
Reaction time		165 ms
MTTF		41 a
MTTF _d		104.74 a
Mission Time (T _M)		20 a
PFH		1.09 E-8 typ.
Indicators/operating means		
LED indication		7 LEDs (communication, status messages)
Electrical specifications		
Operating voltage	U _B	20 ... 30 V DC , PELV
No-load supply current	I ₀	max. 300 mA
Power consumption	P ₀	6 W
Interface		
Interface type		100 BASE-TX
Protocol		PROFINET IO Real-Time (RT) Conformance class B
Transfer rate		100 MBit/s
Conformity		
Fieldbus standard		PROFIsafe in accordance with IEC 61784-3-3; profile 2.4
Functional safety		EN ISO 13849-1:2015 ; EN 61508:2010 part 1-7 ; EN 62061:2005 + AC:2010 + A1:2013 + A2:2015
Shock resistance		EN 60068-2-27:2009
Vibration resistance		EN 60068-2-6:2008
Emitted interference		EN 61000-6-4:2007+A1:2011
Noise immunity		EN 61000-6-7:2015
Photobiological safety		Risk group 2 according to IEC 62471
Approvals and certificates		
CE conformity		CE
UL approval		cULus Listed, Class 2 Power Source, Type 1 enclosure
CCC approval		CCC approval / marking not required for products rated ≤36 V
TÜV approval		TÜV Rheinland 01/205/5669.01/20
Ambient conditions		
Operating temperature		0 ... 45 °C (32 ... 113 °F) , -20 ... 45 °C (-4 ... 113 °F) (noncondensing; prevent icing on the lens!)
Storage temperature		-40 ... 85 °C (-40 ... 185 °F)
Relative humidity		90 % , noncondensing
Altitude		max. 2000 m above MSL
Mechanical specifications		
Connection type		8-pin, M12x1 connector, standard 4-pin, M12x1 socket, D-coded (LAN) 4-pin, M12x1 socket, D-coded (LAN)
Housing width		70 mm
Housing height		70 mm
Housing depth		50 mm
Degree of protection		IP67

Release date: 2023-07-07 Date of issue: 2023-07-07 Filename: 70105248_eng.pdf

Refer to "General Notes Relating to Pepperl+Fuchs Product Information".

Pepperl+Fuchs Group
www.pepperl-fuchs.comUSA: +1 330 486 0001
fa-info@us.pepperl-fuchs.comGermany: +49 621 776 1111
fa-info@de.pepperl-fuchs.comSingapore: +65 6779 9091
fa-info@sg.pepperl-fuchs.com

PEPPERL+FUCHS

Technical Data

Material	
Housing	PC/ABS
Mass	approx. 200 g

Connection

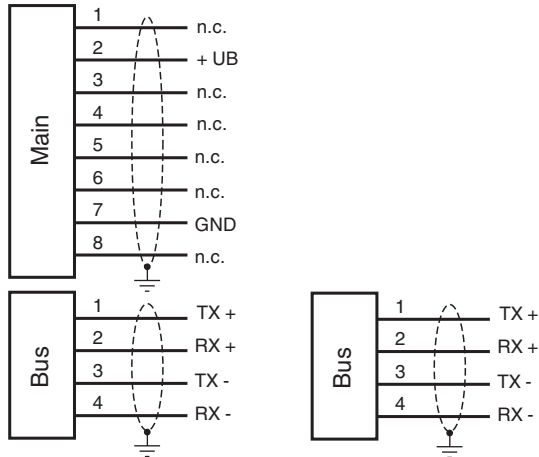

Connection Assignment

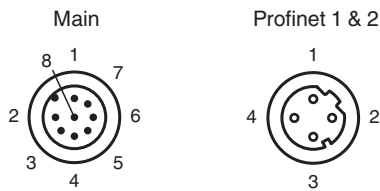

Function Principle

Position Data

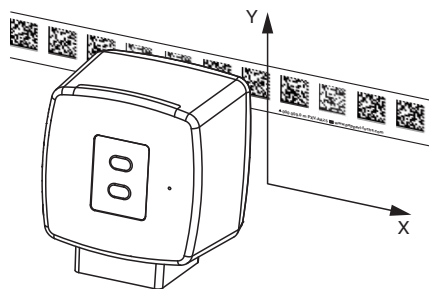



Release date: 2023-07-07 Date of issue: 2023-07-07 Filename: 70105248_eng.pdf

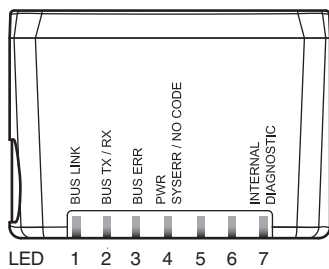
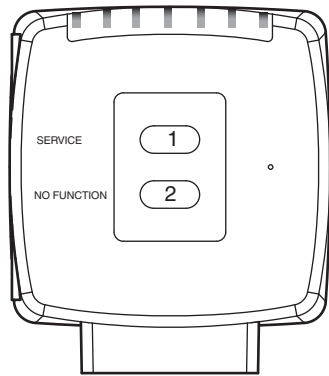







Function Principle



Matching System Components



	PXV*-AA25-*	Data Matrix code tape
	PXV-AAM	DataMatrix metal code bars for positioning safePXV and safePGV read heads

Accessories

	PCV-AG100	Alignment guide for PCV100-* read head
	PCV-SC12	Grounding clip for PCV system
	PCV-SC12A	Grounding clip for PCV system
	PCV-LM25	Marker head for 25 mm code tape
	PCV-MB1	Mounting bracket for PCV* read head
	V19-G-ABG-PG9	Female connector M12 straight A-coded 8-pin, for cable diameter 5 - 8 mm, shielded, field-attachable
	V19-G-ABG-PG9-FE	Female connector, M12, 8-pin, shielded, field attachable
	V1SD-G-GN2M-PUR-E1S-V45-G	Ethernet bus cable M12 plug straight D-coded to RJ45 Ethernet-coded, 4-pin, PUR cable green, Cat5e, shielded, drag chain suitable

Release date: 2023-07-07 Date of issue: 2023-07-07 Filename: 70105248_eng.pdf

Accessories

	V1SD-G-GN5M-PUR-E1S-V45-G	Ethernet bus cable M12 plug straight D-coded to RJ45 Ethernet-coded, 4-pin, PUR cable green, Cat5e, shielded, drag chain suitable
	V1SD-G-GN10M-PUR-E1S-V45-G	Ethernet bus cable M12 plug straight D-coded to RJ45 Ethernet-coded, 4-pin, PUR cable green, Cat5e, shielded, drag chain suitable
	V1SD-G-GN30M-PUR-E1S-V45-G	Ethernet bus cable M12 plug straight D-coded to RJ45 Ethernet-coded, 4-pin, PUR cable green, Cat5e, shielded, drag chain suitable
	V1SD-G-GN2M-PUR-E1S-V1D-G	Ethernet bus cable M12 plug straight to M12 plug straight D-coded, 4-pin, PUR cable green, Cat5e, shielded, UL approved, drag chain suitable
	V1SD-G-GN3M-PUR-E1S-V1D-G	Ethernet bus cable M12 plug straight to M12 plug straight D-coded, 4-pin, PUR cable green, Cat5e, shielded, UL approved, drag chain suitable
	V1SD-G-GN5M-PUR-E1S-V1D-G	Ethernet bus cable M12 plug straight to M12 plug straight D-coded, 4-pin, PUR cable green, Cat5e, shielded, UL approved, drag chain suitable
	V1SD-G-GN15M-PUR-E1S-V1D-G	Ethernet bus cable M12 plug straight to M12 plug straight D-coded, 4-pin, PUR cable green, Cat5e, shielded, UL approved, drag chain suitable
	V19-G-10M-PUR-ABG	Female cordset single-ended M12 straight A-coded, 8-pin, PUR cable grey, shielded
	V19-G-2M-PUR-ABG	Female cordset single-ended M12 straight A-coded, 8-pin, PUR cable grey, shielded
	V19-G-5M-PUR-ABG	Female cordset single-ended M12 straight A-coded, 8-pin, PUR cable grey, shielded

Release date: 2023-07-07 Date of issue: 2023-07-07 Filename: 70105248_eng.pdf

Refer to "General Notes Relating to Pepperl+Fuchs Product Information".

Pepperl+Fuchs Group
www.pepperl-fuchs.com

USA: +1 330 486 0001
fa-info@us.pepperl-fuchs.com

Germany: +49 621 776 1111
fa-info@de.pepperl-fuchs.com

Singapore: +65 6779 9091
fa-info@sg.pepperl-fuchs.com

Additional Information

Function

The reader forms part of the positioning system in the Pepperl+Fuchs incident light process. The reader's features include a camera module and internal illumination unit, enabling it to detect position markers printed onto an adhesive, colored code tape in the form of Data Matrix codes. The code tape is generally mounted stationary on a fixed part of the plant, e.g., elevator shaft, monorail conveyor mounting rails, etc., and the reader is mounted parallel on the moving "vehicle," e.g., elevator car, monorail conveyor chassis, etc.

The positioning system issues position values that achieve the reliability required by SIL 3 and PL e, provided that the device is properly integrated into the plant according to the specifications given in the original instructions.

Mounting and Commissioning

Mount the reader such that the optical surface of the device captures the optimal reading distance to the Data Matrix code tape (see "Technical Data"). The stability of the mounting and the manner in which the vehicle is guided ensure that the reader is not operated outside of its depth of focus range. The code tape must not leave the maximum reading window for the reader during this process.

Displays and Operating Elements

The reader is equipped with the following indicator LEDs for carrying out visual function checks and quick diagnostics:

LEDs

LED	Color	Label	Meaning
1	Green	BUS LINK	PROFINET connection activated
2	Yellow	BUS TX/RX	Data transfer
3	Red	BUS ERR	PROFINET communication error
4	Red/green	PWR SYSERR/NO CODE	Code detected/not detected, error
5	-	-	No function
6	-	-	No function
7	Red/green/yellow	INTERNAL DIAGNOSTIC	Internal diagnostics

The SERVICE button on the back of the device is used for internal service purposes.