



7500 series vent EPV-7500-AA-01

- Must be used in conjunction with a 7500-01-AA* or 7500-MTD-* purge and pressurization control unit
- Low cost, universal mounting, easy to use
- Not gravity dependent
- Various enclosure protection vents for different applications
- Rugged, corrosion-resistant housing
- Mechanical with no cables
- Global third-party approvals for Class I, II, Div. 2 and Zone 2/22

7500 series purge and pressurization system vent, aluminum body and cap



Function

The 7500 series purge and pressurization system consists of a control unit, an enclosure protection vent, and a manual or automatic manifold. The control unit's menu-driven touch screen display makes it easy to select pre-programmed and user-selected variables. The display has 4 LED indicators that allow users to determine system condition from a distance. A digital manifold system such as the 5500-MAN-... can be used to make the 7500 a fully automatic system. Enclosure pressure and leakage are monitored. If a loss in enclosure pressure occurs, the solenoid valve engages to restore the defined pressure settings and/or trigger a pressure drop alarm. The 7500 series system has NEC, CEC, ATEX, CCC and IECEx third-party certifications for Class I, II/Div. 2 Type Z and Zone 2/22 Ex pzc.

Dimensions

EPV-7500-...-01/02 Vent

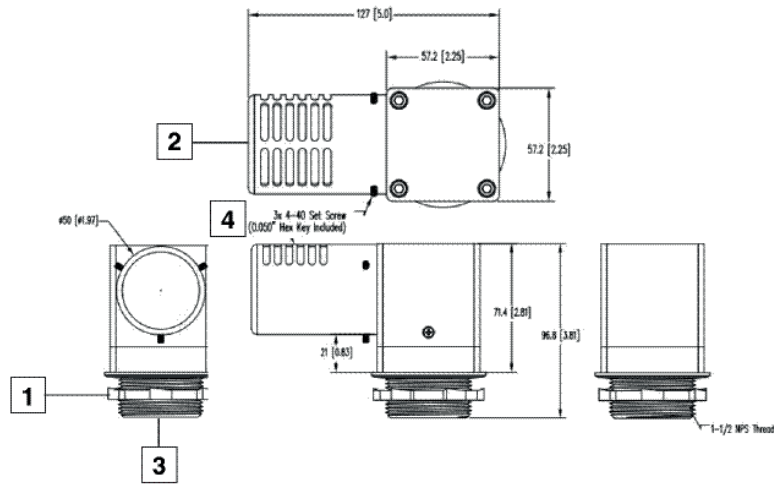

1	1-1/2 NPS thread
2	Exhaust port
3	Inlet port
4	(3) hex key 0.05 inch (included)

Technical Data

General specifications	
Equipment architecture	max. enclosure size 12.7 m ³ (450 ft ³)
Series	7500
System	Type Z Purge ; Ex pzc Purge
Hazardous environment	gas or dust

Release date: 2024-07-09 Date of issue: 2024-07-09 Filename: 70110789_eng.pdf

Refer to "General Notes Relating to Pepperl+Fuchs Product Information".

Technical Data

Pneumatic parameters	
Protective gas supply	compressed air or inert gas, 40 µm filter, free from oil
Maximum pressure	See tables
Purge flow rate	See tables
Flow rate for leakage compensation	EPV-7500.....-01: approx. 25 scfh (707 l/hr) at 0.25 in wc (0.63 mbar) approx. 65 scfh (1838 l/hr) at 0.75 in wc (1.9 mbar) EPV-7500.....-02: approx. 20 scfh (565 l/hr) at 0.25 in wc (0.63 mbar) approx. 48 scfh (1357 l/hr) at 0.75 in wc (1.9 mbar) EPV-7500.....-03 and EPV-7500-AA-04: approx. 15 scfh (424 l/hr) at 0.25 in wc (0.63 mbar) approx. 25 scfh (707 l/hr) at 0.75 in wc (1.9 mbar)
Breaking pressure	EPV-7500.....-01: 0.8 in wc (2.0 mbar) EPV-7500.....-02: 1.4 in wc (3.5 mbar) EPV-7500.....-03: 1.5 in wc (3.8 mbar) EPV-7500-AA-04: 1.4 in wc (3.5 mbar)
Directive conformity	
Electromagnetic compatibility	
Directive 2014/30/EU	EN 61326-1:2013 , FCC CFR 47, part 15, subpart B: 2017, Class A ICES-003, Issue 6:2016, Class A ITE
RoHS	
Directive 2011/65/EU (RoHS)	EN 50581:2012
Conformity	
Degree of protection	Directive conformity: see Declaration of Conformity
Ambient conditions	
Ambient temperature	-40 ... 70 °C (-40 ... 158 °F)
Storage temperature	-40 ... 80 °C (-40 ... 176 °F)
Relative humidity	5 ... 90 %, non-condensing
Vibration resistance	5 ... 100 Hz , 1 g, 12 m/s ² , all axes
Impact resistance	30 g, 11 ms, all axes
Mechanical specifications	
Degree of protection	EPV-7500.....-01/02/04: mounting only Type 4X / IP66 EPV-7500.....-03: Mounting and unit Type 4X / IP66
Material	
Housing	EPV-7500-AA... body and cap: 6061-T6 aluminum EPV-7500-SS... body: 6061-T6 aluminum cap: AISI 316L (1.4404) stainless steel
Spark arrestor	304 Stainless steel
Installation	- any orientation to enclosure - not gravity dependent - internal and external mounting possible
Mass	approx. 1000 g (2.2 lb)
Dimensions	See "Dimensions" section.
Mounting	EPV-7500.....-01/02/03: mounting hole 1.5 in NPT knockout (50.8 mm) hole sealing nut (provided) EPV-7500-AA-04: mounting hole 37 mm with sealing nut (provided)
Data for application in connection with hazardous areas	
Certificate	
Marking	⊕ II 3GD (part of DEMKO 18 ATEX 2025 X)
Directive conformity	
Directive 2014/34/EU	IEC/EN 60079-0 , IEC/EN 60079-2 , IEC/EN 60079-7 , IEC/EN 60079-15 , IEC/EN 60079-18 , IEC/EN 60079-31 Supplements: EN 61010-1:2010, EN 61326-3:2008, EN 61000-6-2:2005
International approvals	
UL approval	
cULus	Class I, Division 2, Groups A, B, C, D T4 (-40 °C ≤ Ta ≤ 70 °C) Class I, Division 2, Groups A, B, C, D, T6 (-40 °C ≤ Ta ≤ 50 °C) Class II, Division 2, Groups F, G T4 (-40 °C ≤ Ta ≤ 70 °C) Class II, Division 2, Groups F, G T6 (-40 °C ≤ Ta ≤ 50 °C)
IECEx approval	part of IECEx UL 18.0022X

Release date: 2024-07-09 Date of issue: 2024-07-09 Filename: 70110789_eng.pdf

Technical Features

Flow Rates

EPV-7500-...-01 Vent Flow vs. Enclosure Pressure

ft ³ /min	Inches of water	l/min	mbar
5	1.28	141	3.19
7	1.44	198	3.59
10	1.64	283	4.09
12	1.80	339	4.48
15	2.10	424	5.23
17	2.30	481	5.73
20	2.53	566	6.30
25	2.95	707	7.35
30	3.50	849	8.71
35	4.15	991	10.33

EPV-7500-...-02 Vent Flow vs. Enclosure Pressure

ft ³ /min	Inches of water	l/min	mbar
5	2.15	141	5.36
7	2.35	198	5.85
10	2.65	283	6.60
12	2.85	339	7.10
15	3.15	424	7.84
17	3.35	481	8.34
20	3.65	566	9.09
25	4.25	707	10.58
30	4.75	849	11.82
35	5.25	991	13.07

EPV-7500-...-03 Vent Flow vs. Enclosure Pressure

ft ³ /min	Inches of water	l/min	mbar
4	2.00	113	4.98
6	2.20	170	5.48
8	2.40	226	5.98
10	2.70	282	6.72
12	3.50	339	8.71
14	4.65	396	11.58
16	6.10	452	15.18

EPV-7500-AA-04 Vent Flow vs. Enclosure Pressure

ft ³ /min	Inches of water	l/min	mbar
3	2.50	85	6.23
4	2.75	113	6.85
5	3.10	141	7.72
6	3.40	170	8.47
7	3.80	198	9.46
8	4.20	226	10.46
9	4.60	254	11.45
10	5.00	339	12.45
11	5.50	311	13.69
12	6.10	339	15.18
13	6.80	368	16.93
14	7.70	396	19.17

Type Code

Release date: 2024-07-09 Date of issue: 2024-07-09 Filename: 70110789_eng.pdf

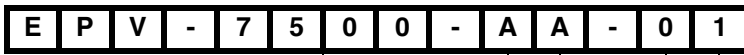

Configuration

- 01** 35 SCFM (990 l/min) max flow, brk. press. 0.8" wc (2 mbar)
- 02** 35 SCFM (990 l/min) max flow, brk. press. 1.4" wc (3.5 mbar)
- 03** 16 SCFM (452 l/min) max flow, brk. press. 1.5" wc (3.8 mbar)
- 04*** 14 SCFM (396 l/min) max flow, brk. press. 1.4" wc (3.5 mbar)

Material

- AA** Body and cap: 6061-T6 aluminum
- SS** Body: 6061-T6 Aluminum, Cap: 316L stainless steel

Series of vent

7500 7500 Series

* The only possible combination with these options is "EPV-7500-AA-04"

Release date: 2024-07-09 Date of issue: 2024-07-09 Filename: 70110789_eng.pdf