



Retroreflective sensor

RLK31-54-B043/25/31/115b



- Cost-optimized series for standard tasks
- Large construction with small housing
- Relay output
- Version with relay's Common terminal tied to +UB

Retroreflective sensor with polarization filter, plastic housing, 9 m detection range, red light, light on, DC version, relay contact output, no control elements, single-ended male cordset with right-angle V11 connector



Dimensions

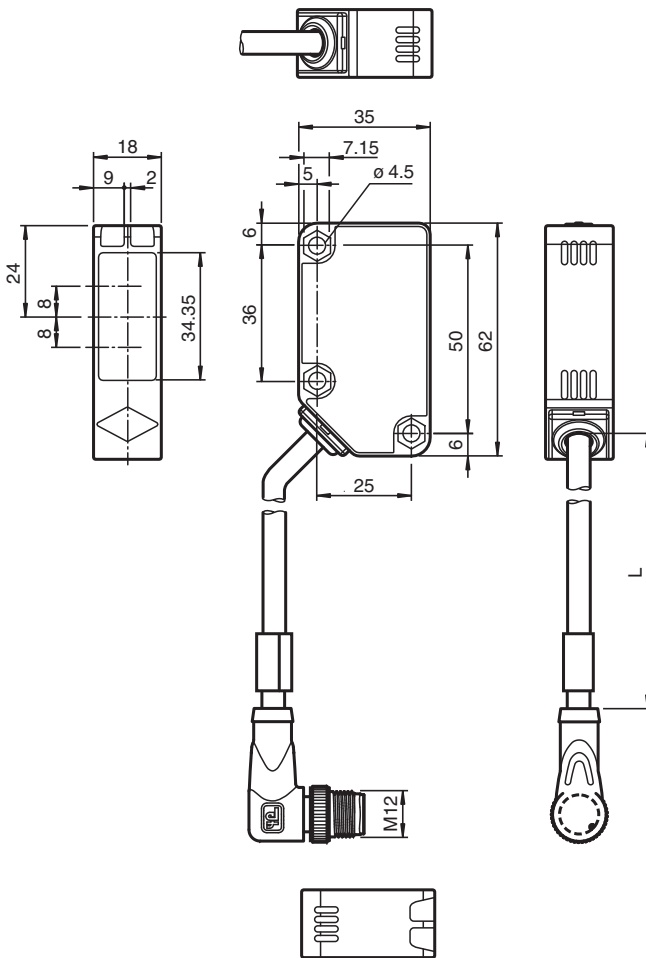

Release date: 2023-10-13 Date of issue: 2023-10-13 Filename: 70125870_eng.pdf

Technical Data

General specifications

Refer to "General Notes Relating to Pepperl+Fuchs Product Information".

Pepperl+Fuchs Group
www.pepperl-fuchs.com

USA: +1 330 486 0001
fa-info@us.pepperl-fuchs.com

Germany: +49 621 776 1111
fa-info@de.pepperl-fuchs.com

Singapore: +65 6779 9091
fa-info@sg.pepperl-fuchs.com

PF PEPPERL+FUCHS

Technical Data

Effective detection range	0 ... 9000 mm	
Reflector distance	20 ... 9000 mm	
Threshold detection range	12 m	
Reference target	reflector C110-2	
Light source	LED	
Light type	modulated visible red light , 630 nm	
Polarization filter	yes	
Diameter of the light spot	approx. 200 mm at a distance of 6 m	
Opening angle	3 °	
Ambient light limit	50000 Lux	
Functional safety related parameters		
MTTF _d	790 a	
Mission Time (T _M)	20 a	
Diagnostic Coverage (DC)	0 %	
Indicators/operating means		
Operation indicator	LED green: power on	
Function indicator	LED yellow: 1. LED lit constantly: signal > 2 x switching point (function reserve) 2. LED flashes: signal between 1 x switching point and 2 x switching point 3. LED off: signal < switching point	
Electrical specifications		
Operating voltage	U _B	12 ... 30 V DC
No-load supply current	I ₀	≤ 40 mA
Power consumption	P ₀	≤ 2 VA
Output		
Switching type	light-on	
Signal output	relay, 1 NO	
Switching voltage	max. 30 V DC	
Switching current	max. 3 A	
Switching power	DC: max. 150 W	
Switching frequency	f	20 Hz
Response time	≤ 25 ms	
Conformity		
Product standard	EN 60947-5-2	
Ambient conditions		
Ambient temperature	-25 ... 55 °C (-13 ... 131 °F)	
Storage temperature	-40 ... 70 °C (-40 ... 158 °F)	
Mechanical specifications		
Housing width	18 mm	
Housing height	62 mm	
Housing depth	35 mm	
Degree of protection	IP67	
Connection	Single-ended male cordset, right-angled, M12, 3-pin	
Material		
Housing	Polycarbonate	
Optical face	PMMA	
Cable		
Length	L	3 m
Mass	225 g	

Release date: 2023-10-13 Date of issue: 2023-10-13 Filename: 70125870_eng.pdf

Connection

Option:

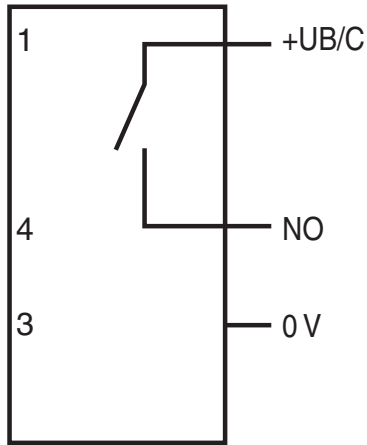

Connection Assignment

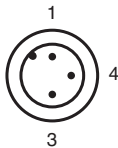

Wire colors in accordance with EN 60947-5-2

1	BN	(brown)
3	BU	(blue)
4	BK	(black)

Characteristic Curve

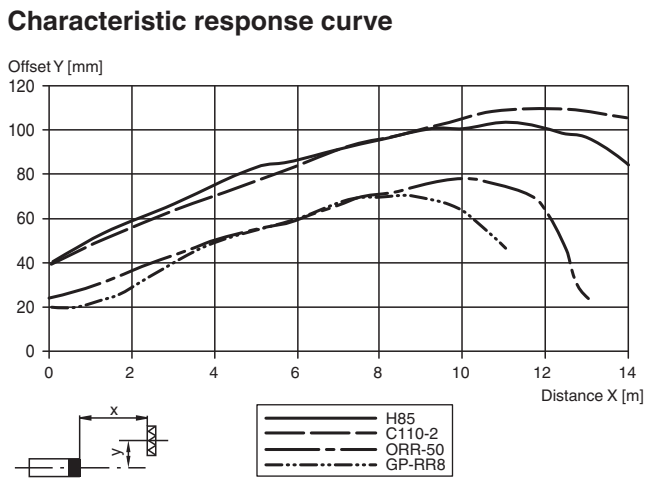





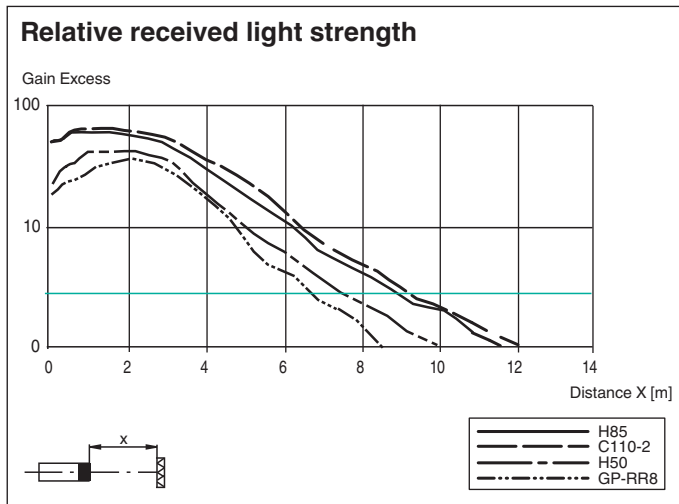

Release date: 2023-10-13 Date of issue: 2023-10-13 Filename: 70125870_eng.pdf

Refer to "General Notes Relating to Pepperl+Fuchs Product Information".

Characteristic Curve



Accessories

	OMH-RL31-01	Mounting bracket
	OMH-RL31-02	Mounting bracket narrow
	OMH-RL31-03	Mounting bracket narrow
	OMH-RL31-04	Mounting aid for round steel \varnothing 12 mm or sheet 1.5 mm ... 3 mm
	OMH-RL31-05	Mounting bracket for mounting on flat surfaces with 2 M4 screws
	OMH-RL31-06	Stainless steel mounting bracket with adjustable half clamp on the side