



Retroreflective sensor OBR10M-R202-K6-4R



- Reliable detection of foil wrapped objects
- Version for universal voltages
- Medium design with versatile mounting options
- Degree of protection IP67
- Mounting on full metal sockets
- Very bright, highly visible light spot
- Highly visible LEDs for Power ON and switching state
- Easy to use
- Image is generic for this device type and may deviate from the specific variant



Function

The optical sensors of this series for applications in standard automation have a modern housing design. The sensors are characterized by the many mounting options, easy handling and highly visible LED status indicators. The integrated full metal bushings ensure long-term secure and dimensionally stable mounting.

Due to the integrated all-voltage power supply, the sensors can be operated in the range of 24 ... 240 V AC/DC.

Dimensions

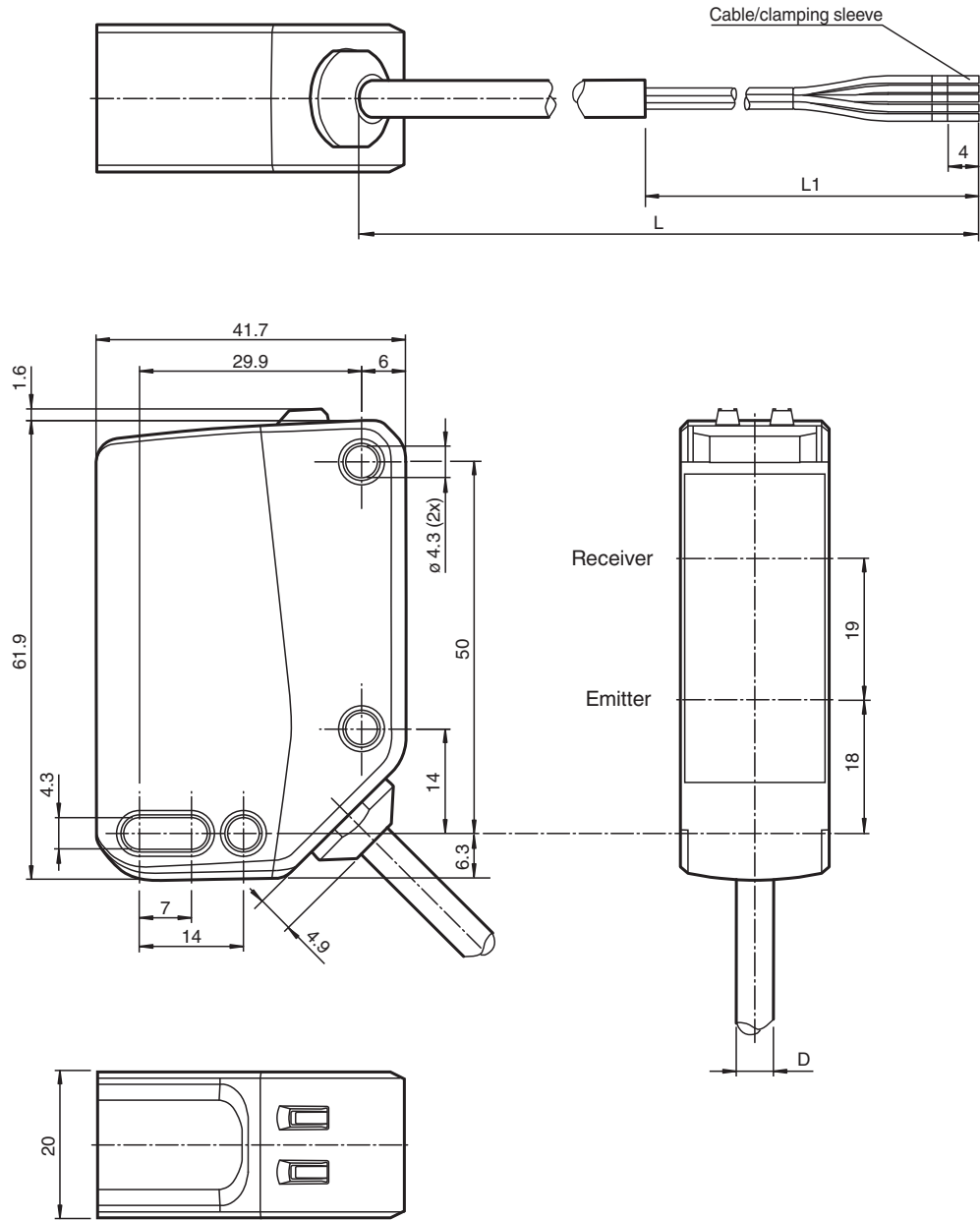

Release date: 2024-01-31 Date of issue: 2024-01-31 Filename: 70128080-100068_eng.pdf

Technical Data

General specifications	
Effective detection range	0 ... 10 m
Reflector distance	0.05 ... 10 m
Threshold detection range	12 m
Reference target	H85-2 reflector
Light source	LED
Light type	modulated visible red light
LED risk group labelling	exempt group

Refer to "General Notes Relating to Pepperl+Fuchs Product Information".

Technical Data

Polarization filter		yes
Diameter of the light spot		approx. 300 mm at a distance of 10 m
Opening angle		2 °
Ambient light limit		EN 60947-5-2 : 60000 Lux
Functional safety related parameters		
MTTF _d		642 a
Mission Time (T _M)		20 a
Diagnostic Coverage (DC)		0 %
Indicators/operating means		
Operation indicator		LED green: power on
Function indicator		Yellow LED: Permanently lit - light path clear Permanently off - object detected Flashing (4 Hz) - insufficient operating reserve Flashing (8 Hz) - fault detected, the outputs maintain the status
Control elements		
Electrical specifications		
Operating voltage	U _B	24 ... 240 V AC/DC
No-load supply current	I ₀	< 30 mA at 24 V Operating voltage
Protection class		II
Rated insulation voltage	U _i	250 V
Rated impulse withstand voltage	U _{imp}	2500 V
Power consumption	P ₀	≤ 3.5 VA
Fuse		Safety fuse ≤ 2 A (slow-blow) according to IEC 60127-2 Sheet 1 Recommendation: after a short circuit, check that the device is functioning correctly.
Output		
Switching type		Q - BK: normally-open / dark-on /Q - GY: normally-closed / light-on C - WH: Common
Signal output		Relay, 1 alternator
Switching voltage		max. 240 V AC/DC
Switching current		max. 2.5 A , see section characteristic curve
Switching power		DC: max. 95 W AC: max. 600 VA
Usage category		DC-12 , DC-13 , AC-12 u. AC-140
Switching frequency	f	25 Hz
Response time		≤ 20 ms
Conformity		
Product standard		EN 60947-5-2 , EN 60947-1
Approvals and certificates		
UL approval		E87056 , cULus Listed
Ambient conditions		
Ambient temperature		-30 ... 60 °C (-22 ... 140 °F) , fixed cable -20 ... 60 °C (-4 ... 140 °F) , movable cable not appropriate for conveyor chains
Storage temperature		-40 ... 70 °C (-40 ... 158 °F)
Pollution degree		3
Mechanical specifications		
Degree of protection		IP67
Connection		2 m fixed cable
Material		
Housing		PC (Polycarbonate)
Optical face		PMMA
Mass		approx. 120 g
Dimensions		
Height		62 mm
Width		20 mm
Depth		42 mm

Release date: 2024-01-31 Date of issue: 2024-01-31 Filename: 70128080-100068_eng.pdf

Refer to "General Notes Relating to Pepperl+Fuchs Product Information".

Pepperl+Fuchs Group
www.pepperl-fuchs.com

USA: +1 330 486 0001
fa-info@us.pepperl-fuchs.com

Germany: +49 621 776 1111
fa-info@de.pepperl-fuchs.com

Singapore: +65 6779 9091
fa-info@sg.pepperl-fuchs.com

 **PEPPERL+FUCHS**

Technical Data

Cable length	2 m
--------------	-----

Connection

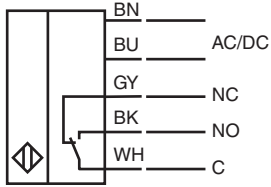

Assembly

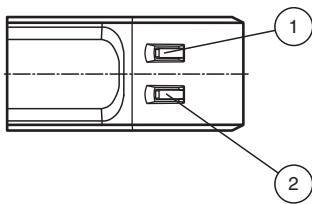

1	Function indicator	YE
2	Operation indicator	GN

Characteristic Curve

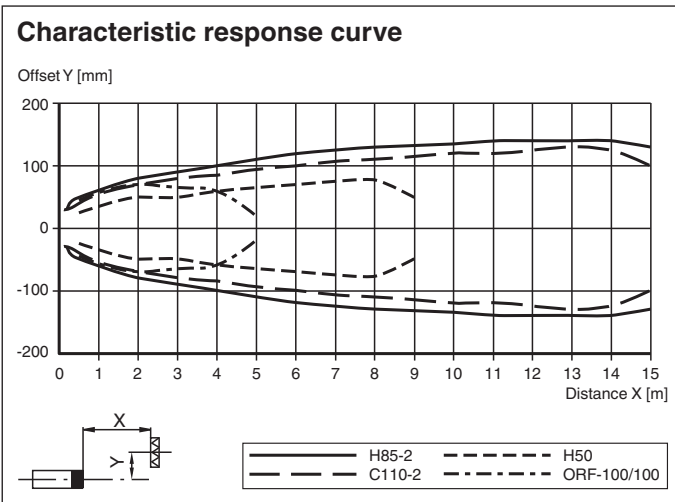

Release date: 2024-01-31 Date of issue: 2024-01-31 Filename: 70128080-100068_eng.pdf

Characteristic Curve

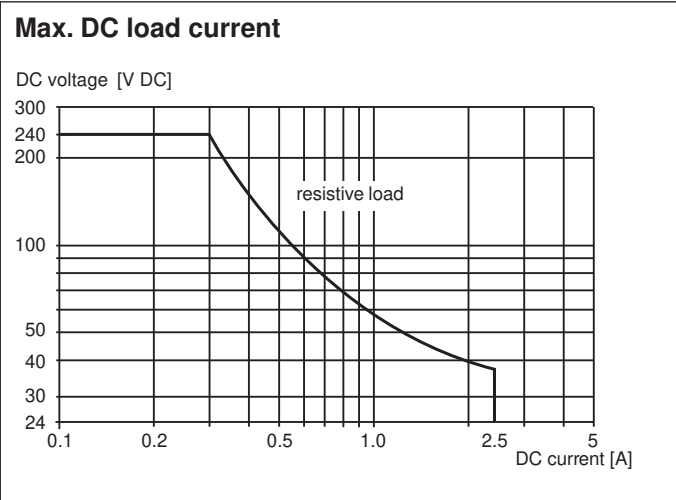
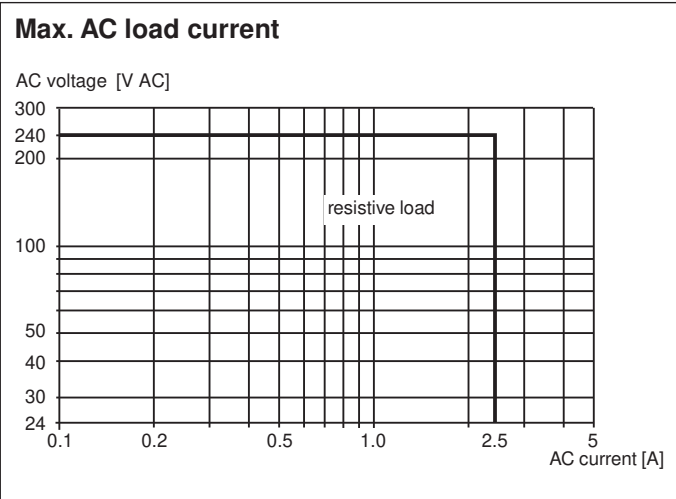
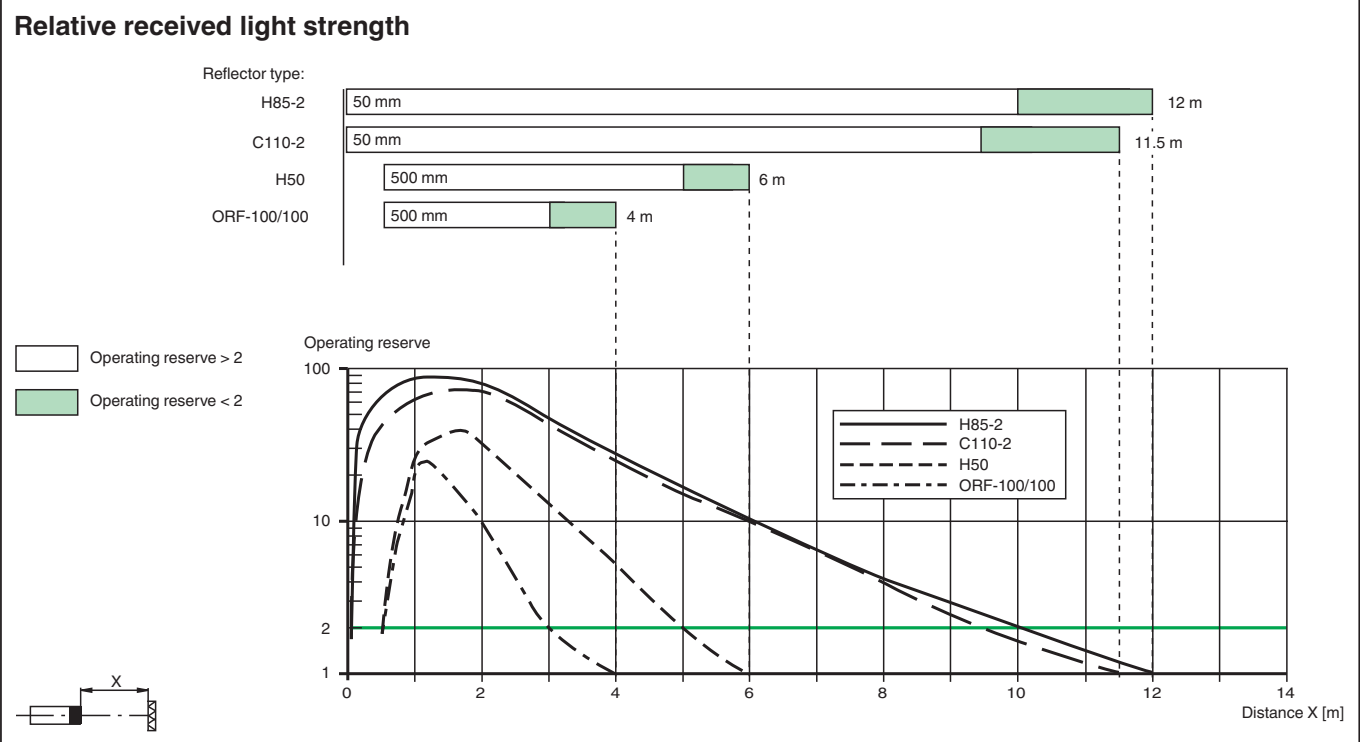

Release date: 2024-01-31 Date of issue: 2024-01-31 Filename: 70128080-100068_eng.pdf

Refer to "General Notes Relating to Pepperl+Fuchs Product Information".