

# Ultrasonic sensor

## UB300-18GM40-E5-V1-Y70128214

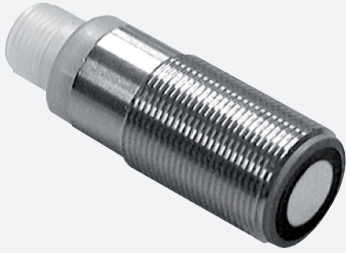

- Short design, 40 mm
- Function indicators visible from all directions
- Switching output
- Program input
- Temperature compensation
- Customer-specific configuration

Single head system



### Dimensions

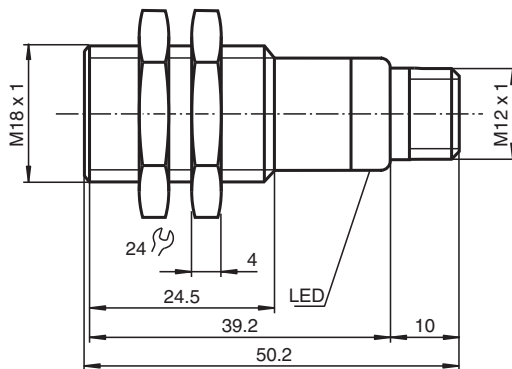

### Technical Data

#### General specifications

Sensing range	35 ... 300 mm
Adjustment range	50 ... 300 mm
Dead band	0 ... 35 mm
Standard target plate	100 mm x 100 mm
Transducer frequency	approx. 390 kHz
Response delay	approx. 50 ms

#### Indicators/operating means

LED green	Power on
-----------	----------

Release date: 2023-02-15 Date of issue: 2023-02-15 Filename: 70128214\_eng.pdf

Refer to "General Notes Relating to Pepperl+Fuchs Product Information".

Pepperl+Fuchs Group  
www.pepperl-fuchs.com

USA: +1 330 486 0001  
fa-info@us.pepperl-fuchs.com

Germany: +49 621 776 1111  
fa-info@de.pepperl-fuchs.com

Singapore: +65 6779 9091  
fa-info@sg.pepperl-fuchs.com

PEPPERL+FUCHS

## Technical Data

LED yellow		indication of the switching state flashing: program function object detected
LED red		solid red: Error red, flashing: program function, object not detected
<b>Electrical specifications</b>		
Operating voltage	$U_B$	10 ... 30 V DC , ripple 10 % <sub>SS</sub>
No-load supply current	$I_0$	≤ 20 mA
<b>Input</b>		
Input type		1 program input operating distance 1: $-U_B \dots +1$ V, operating distance 2: $+6$ V ... $+U_B$ input impedance: > 4,7 kΩ program pulse: ≥ 1 s
<b>Output</b>		
Output type		1 switching output E5, PNP NO/NC, programmable
Rated operating current	$I_e$	200 mA , short-circuit/overload protected
Default setting		Normally open (NO) Switch point A2: 150 mm
Voltage drop	$U_d$	≤ 3 V
Repeat accuracy		≤ 1 %
Switching frequency	f	≤ 13 Hz
Range hysteresis	H	1 % of the set operating distance
Temperature influence		± 1.5 % of full-scale value
<b>Compliance with standards and directives</b>		
Standard conformity		
Standards		EN IEC 60947-5-2:2020 IEC 60947-5-2:2019
<b>Approvals and certificates</b>		
UL approval		cULus Listed, Class 2 Power Source
CCC approval		CCC approval / marking not required for products rated ≤36 V
<b>Ambient conditions</b>		
Ambient temperature		-25 ... 70 °C (-13 ... 158 °F)
Storage temperature		-40 ... 85 °C (-40 ... 185 °F)
<b>Mechanical specifications</b>		
Connection type		Connector plug M12 x 1 , 4-pin
Housing diameter		18 mm
Degree of protection		IP67
Material		
Housing		brass, nickel-plated
Transducer		epoxy resin/hollow glass sphere mixture; foam polyurethane, cover PBT
Mass		25 g
<b>Factory settings</b>		
Output		Switch point A2: 150 mm Normally open (NO)

## Connection

**Standard symbol/Connections:**  
(version E5, pnp)

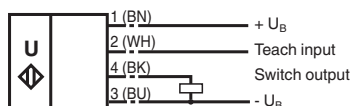

Core colours in accordance with EN 60947-5-2.

Release date: 2023-02-15 Date of issue: 2023-02-15 Filename: 70128214\_eng.pdf

## Connection Assignment



Wire colors in accordance with EN 60947-5-2

1	BN	(brown)
2	WH	(white)
3	BU	(blue)
4	BK	(black)

## Characteristic Curve

### Characteristic response curve

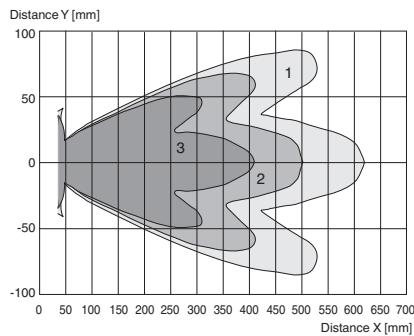

Curve 1: flat surface 100 mm x 100 mm  
 Curve 2: flat surface 10 mm x 10 mm  
 Curve 3: round bar, Ø 25 mm



### Programmable output modes









- Window mode, normally open mode  
 $A1 < A2$ :
- Window mode, normally closed mode  
 $A2 < A1$ :
- One switch point, normally open mode  
 $A1 \rightarrow \infty$ :
- One switch point, normally closed mode  
 $A2 \rightarrow \infty$ :
- $A1 \rightarrow \infty, A2 \rightarrow \infty$ : Object presence detection mode  
 Object detected: Switch output closed  
 No object detected: Switch output open

## Accessories

	<b>UB-PROG2</b>	Programming unit
	<b>OMH-04</b>	Mounting aid for round steel $\varnothing$ 12 mm or sheet 1.5 mm ... 3 mm

Release date: 2023-02-15 Date of issue: 2023-02-15 Filename: 70128214\_eng.pdf

**Accessories**

	<b>V1-G-2M-PVC</b>	Female cordset single-ended M12 straight A-coded, 4-pin, PVC cable grey
	<b>V1-W-2M-PUR</b>	Female cordset single-ended M12 angled A-coded, 4-pin, PUR cable grey
	<b>UVW90-K18</b>	Ultrasonic -deflector
	<b>M18K-VE</b>	Plastic nuts with centering ring for the vibration-free mounting of cylindrical sensors
	<b>CPZ18B03</b>	Mounting Bracket with swivel nut
	<b>BF 18-F</b>	Plastic mounting adapter, 18 mm
	<b>BF 5-30</b>	Universal mounting bracket for cylindrical sensors with a diameter of 5 ... 30 mm
	<b>BF 18</b>	Mounting flange, 18 mm

Release date: 2023-02-15 Date of issue: 2023-02-15 Filename: 70128214\_eng.pdf

Refer to "General Notes Relating to Pepperl+Fuchs Product Information".

Pepperl+Fuchs Group  
www.pepperl-fuchs.com

USA: +1 330 486 0001  
fa-info@us.pepperl-fuchs.com

Germany: +49 621 776 1111  
fa-info@de.pepperl-fuchs.com

Singapore: +65 6779 9091  
fa-info@sg.pepperl-fuchs.com

**Teach-In**

**Adjusting the switching points**

The ultrasonic sensor features a switch output with two teachable switching points. These are set by applying the supply voltage  $-U_B$  or  $+U_B$  to the TEACH-IN input. The supply voltage must be applied to the TEACH-IN input for at least 1 s. LEDs indicate whether the sensor has recognised the target during the TEACH-IN procedure. Switching point A1 is taught with  $-U_B$ , A2 with  $+U_B$ .

Five different output functions can be set

1. Window mode, normally-open function
2. Window mode, normally-closed function
3. one switching point, normally-open function
4. one switching point, normally-closed function
5. Detection of object presence

**TEACH-IN window mode, normally-open function**

- Set target to near switching point
- TEACH-IN switching point A1 with  $-U_B$
- Set target to far switching point
- TEACH-IN switching point A2 with  $+U_B$

**TEACH-IN window mode, normally-closed function**

- Set target to near switching point
- TEACH-IN switching point A2 with  $+U_B$
- Set target to far switching point
- TEACH-IN switching point A1 with  $-U_B$

**TEACH-IN switching point, normally-open function**

- Set target to near switching point
- TEACH-IN switching point A2 with  $+U_B$
- Cover sensor with hand or remove all objects from sensing range
- TEACH-IN switching point A1 with  $-U_B$

**TEACH-IN switching point, normally-closed function**

- Set target to near switching point
- TEACH-IN switching point A1 with  $-U_B$
- Cover sensor with hand or remove all objects from sensing range
- TEACH-IN switching point A2 with  $+U_B$

**TEACH-IN detection of objects presence**

- Cover sensor with hand or remove all objects from sensing range
- TEACH-IN switching point A1 with  $-U_B$
- TEACH-IN switching point A2 with  $+U_B$

**LED Displays**

Displays in dependence on operating mode	Red LED	Yellow LED
<b>TEACH-IN switching point:</b>		
Object detected	off	flashes
No object detected	flashes	off
Object uncertain (TEACH-IN invalid)	On	off
Normal operation	off	Switching state
Fault	on	Previous state

**Installation Conditions**

If the sensor is installed at places, where the environment temperature can fall below 0 °C, for the sensors fixation, one of the mounting flanges BF18, BF18-F or BF 5-30 must be used.

In case of direct mounting of the sensor in a through hole using the steel nuts, it has to be fixed at the middle of the housing thread. If a fixation at the front end of the threaded housing is required, plastic nuts with centering ring (accessories) must be used.

Release date: 2023-02-15 Date of issue: 2023-02-15 Filename: 70128214\_eng.pdf

Refer to "General Notes Relating to Pepperl+Fuchs Product Information".