



Y connection cable V1S-G-BK0,3M-PUR-U-T-0,3M-V1-G

- Easy merging of two signals at a single M12 slot
- Suitable for drag chains and abrasion resistant
- Suitable for robotic applications / torsion resistant
- Degree of protection IP67 / IP68 / IP69
- Free of paint wetting interfering substances
- Resistant to microbes and hydrolysis
- UV resistant
- cURus approval
- Halogen-free
- Knurled nut suitable for tool assembly
- Immunity to vibration, with mechanical latching

Y connection cable M12 socket straight A-coded 4-pin to 2x M12 plug straight A-coded 4-pin, 3x PUR cable black, UL approved, drag chain suitable, torsion resistant



Dimensions

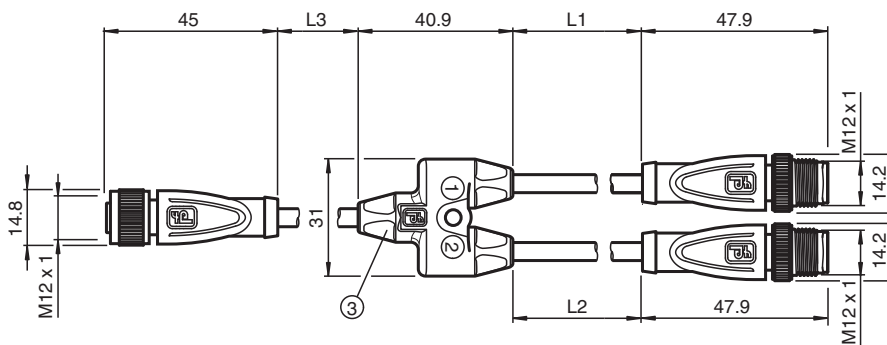

Technical Data

General specifications

Connector 1	
Connection	plug
Construction type	M12
Style	straight
Locking	screw connection
Number of pins	3
Coding	A-coded
Customization	pin 2 not connected
Connector 2	
Connection	plug
Construction type	M12
Style	straight
Locking	screw connection
Number of pins	3

Release date: 2023-05-04 Date of issue: 2023-05-04 Filename: 70128472_eng.pdf

Refer to "General Notes Relating to Pepperl+Fuchs Product Information".

Pepperl+Fuchs Group
www.pepperl-fuchs.com

USA: +1 330 486 0001
fa-info@us.pepperl-fuchs.com

Germany: +49 621 776 1111
fa-info@de.pepperl-fuchs.com

Singapore: +65 6779 9091
fa-info@sg.pepperl-fuchs.com

PEPPERL+FUCHS

Technical Data

Coding	A-coded	
Customization	pin 2 not connected	
Connector 3		
Connection	socket	
Construction type	M12	
Style	straight	
Locking	screw connection	
Number of pins	4	
Coding	A-coded	
UL File Number	E231213	
Electrical specifications		
Operating voltage	U _B	max. 48 V AC / 60 V DC
Operating current	I _B	max. 4 A
Conformity		
Degree of protection	EN 60529	
Plug connection	connector M12 x 1 : IEC 61076-2-101	
Flammability	UL 1581; DIN EN 60332-2-2	
Halogen-free	IEC 60754-1	
Approvals and certificates		
UL approval	AWM STYLE 20549 AWM I/II A/B 80°C 300V FT2 (cable)	
Maximum permissible operating voltage	max. 30 V AC/DC	
Ambient conditions		
Ambient temperature		
Plug connector	-40 ... 90 °C (-40 ... 194 °F)	
Cable, fixed	-40 ... 80 °C (-40 ... 176 °F)	
Cable, flexing	-20 ... 80 °C (-4 ... 176 °F)	
Pollution degree	3	
Mechanical specifications		
Plug connector		
Tightening torque	max. 0.6 Nm	
Loosening protection	available	
Tool installation	straight knurling	
Mating cycles	min. 100	
Degree of protection	IP67 / IP68 / IP69	
Cable		
Sheath diameter	4.3 mm	
Bending radius	> 10 x cable diameter, moving > 5 x cable diameter, fixed	
Sheath stripping force	max. 80 N / 300 mm	
Sheath color	black (similar to RAL 9005)	
Number of cores	4	
Core cross section	0.34 mm ²	
Cores color	Core 1: brown Core 2: white Core 3: blue Core 4: black	
Core construction	42 x 0.1 mm Ø	
Length	L	L1 = 30 mm L2 = 30 mm L3 = 30 mm
Cable code	Li 9Y 11Y 4 x 0.34	
Drag chain suitability		
Drag chain cycles	min. 5000000	
Motion velocity	max. 3.3 m/s	
Traverse distance	max. 5 m	

Release date: 2023-05-04 Date of issue: 2023-05-04 Filename: 70128472_eng.pdf

Refer to "General Notes Relating to Pepperl+Fuchs Product Information".

Pepperl+Fuchs Group
www.pepperl-fuchs.comUSA: +1 330 486 0001
fa-info@us.pepperl-fuchs.comGermany: +49 621 776 1111
fa-info@de.pepperl-fuchs.comSingapore: +65 6779 9091
fa-info@sg.pepperl-fuchs.com

PEPPERL+FUCHS





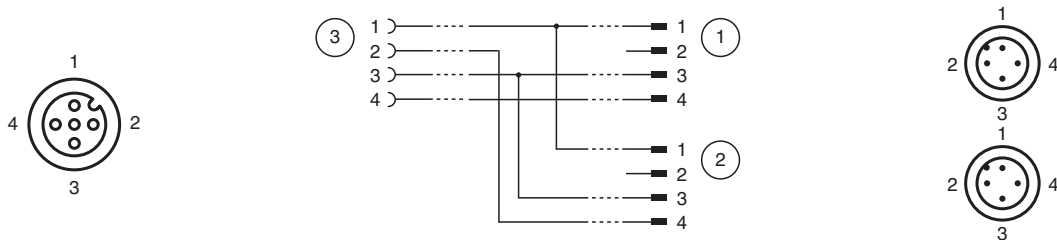

Technical Data

Acceleration	max. 5 m/s ²
Torsion cycles	min. 1000000
Torsional stress	± 180 °/m
Material	
PWIS free	yes
Halogen-free	yes
Plug connector	
Screw connection	Zinc diecast, nickel-plated
Body	TPU, black
Contact surface	Au
Flammability	V-2
Cable	
Sheathing	PUR based on polyether
Core insulation	PP
UV resistance	yes
Chemical resistance	good
Oil resistance	yes
Cooling lubricant resistance	yes
Microbial resistance	yes
Hydrolysis resistance	yes
Flammability	FT2

Connection



Accessories

	MH V1-SCREWDRIVER	Torque screwdriver (0.6 Nm)
	MH V1-BIT M12	plug-in cap M12
	V1/V3-LABELHOLDER	Label holder
	V1/V3-LABEL	Label plate
	MH V1-Holder	Modular universal holder for M12 connectors
	V1-CLIP	Unlocking protector for M12 connector
	V1-MARKING-RING-COLOR	Marking rings for M12 connectors, various colors

Release date: 2023-05-04 Date of issue: 2023-05-04 Filename: 70128472_eng.pdf