

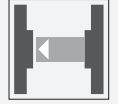

Thru-beam sensor (pair)

M100/MV100-RT/35/76b/102/115-5



- Miniature design
- Easy to use
- Very bright, highly visible light spot
- Full metal thread mounting
- Highly visible LEDs for Power ON and switching state
- Not sensitive to ambient light

Thru-beam sensor, 20 m detection range, red light, light/dark on, DC version, NPN output, sensitivity adjuster, emitter switch-off, fixed cable



Function

The optical sensors of this series are suitable for both standard and demanding applications. The series features a miniature housing design, two M3 metal-threaded mounting holes and a highly visible LED status indicator. Each device is equipped with a sensitivity adjuster and a light-on/dark-on changeover switch for increased flexibility. A wide variety of versions are available in both infrared light and red light with PowerBeam for easy alignment. Special versions with BlueBeam are suitable for challenging applications like those in the solar and battery industries.

Dimensions

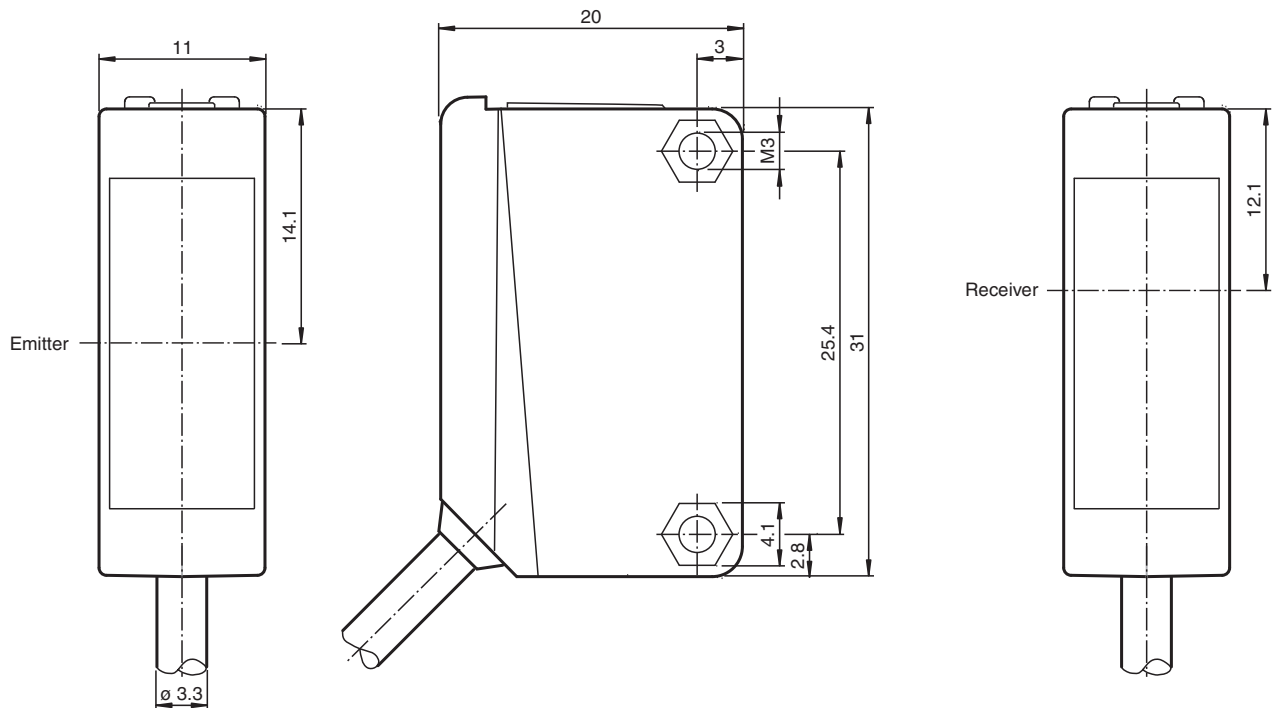

Release date: 2023-03-28 Date of issue: 2023-03-28 Filename: 70132093_eng.pdf

Refer to "General Notes Relating to Pepperl+Fuchs Product Information".

Pepperl+Fuchs Group
www.pepperl-fuchs.com

USA: +1 330 486 0001
fa-info@us.pepperl-fuchs.com

Germany: +49 621 776 1111
fa-info@de.pepperl-fuchs.com

Singapore: +65 6779 9091
fa-info@sg.pepperl-fuchs.com

PF PEPPERL+FUCHS

Technical Data

System components		
Emitter		M100-RT/35/76b/115-5M
Receiver		MV100-RT/35/102/115-5M
General specifications		
Effective detection range		0 ... 20 m
Threshold detection range		30 m
Light source		LED
Light type		modulated visible red light
Diameter of the light spot		approx. 2 m at a distance of 30 m
Opening angle		approx. 2 °
Optical face		frontal
Ambient light limit		EN 60947-5-2
Functional safety related parameters		
MTTF _d		860 a
Mission Time (T _M)		20 a
Diagnostic Coverage (DC)		0 %
Indicators/operating means		
Operation indicator		LED green: power on
Function indicator		Receiver: LED yellow, lights up when light beam is free, flashes when falling short of the operating reserve ; OFF when light beam is interrupted
Control elements		sensitivity adjustment
Control elements		Light-on/dark-on changeover switch
Electrical specifications		
Operating voltage	U _B	10 ... 30 V DC
Ripple		max. 10 %
No-load supply current	I ₀	Emitter: ≤ 15 mA Receiver: ≤ 8 mA
Input		
Test input		emitter deactivation at 0 V
Output		
Switching type		The switching type of the sensor is adjustable. The default setting is: light-on
Signal output		1 NPN output, short-circuit protected, reverse polarity protected, open collector
Switching voltage		max. 30 V DC
Switching current		max. 100 mA , resistive load
Voltage drop	U _d	≤ 1.5 V DC
Switching frequency	f	250 Hz
Response time		2 ms
Conformity		
Product standard		EN 60947-5-2
Approvals and certificates		
UL approval		cULus Listed, Class 2 Power Source or listed Power Supply with a limited voltage output with (maybe integrated) fuse (max. 3.3 A according UL248), Type 1 enclosure
CCC approval		CCC approval / marking not required for products rated ≤36 V
Ambient conditions		
Ambient temperature		-30 ... 60 °C (-22 ... 140 °F)
Storage temperature		-40 ... 70 °C (-40 ... 158 °F)
Mechanical specifications		
Housing width		11 mm
Housing height		31 mm
Housing depth		20 mm
Degree of protection		IP67
Connection		5 m fixed cable
Material		
Housing		PC (Polycarbonate)

Release date: 2023-03-28 Date of issue: 2023-03-28 Filename: 70132093_eng.pdf

Refer to "General Notes Relating to Pepperl+Fuchs Product Information".

Pepperl+Fuchs Group
www.pepperl-fuchs.comUSA: +1 330 486 0001
fa-info@us.pepperl-fuchs.comGermany: +49 621 776 1111
fa-info@de.pepperl-fuchs.comSingapore: +65 6779 9091
fa-info@sg.pepperl-fuchs.com

PEPPERL+FUCHS

Technical Data

Optical face	PMMA
Mass	approx. 110 g (emitter and receiver)
Tightening torque, fastening screws	0.6 Nm
Cable length	5 m

Connection

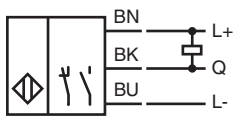
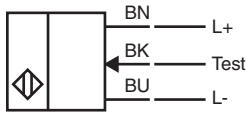

Assembly

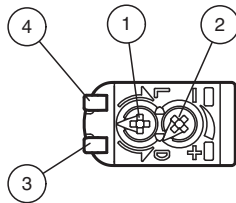

1	Light-Dark-switching	
2	Sensitivity adjuster	
3	Signal display	yellow
4	Operating display	green

Characteristic Curve

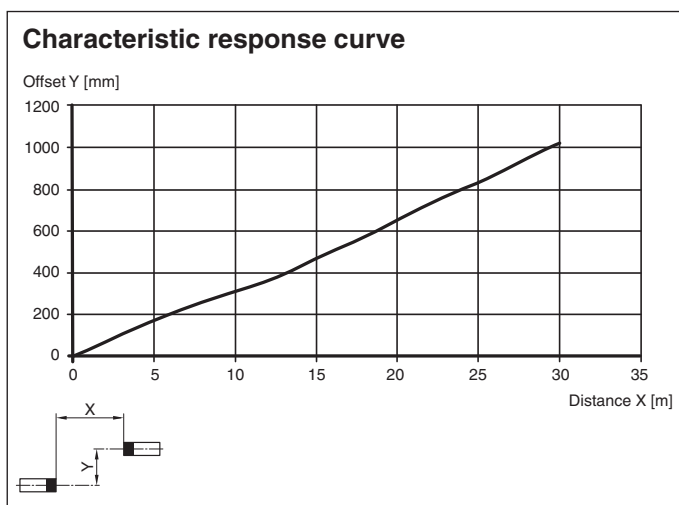





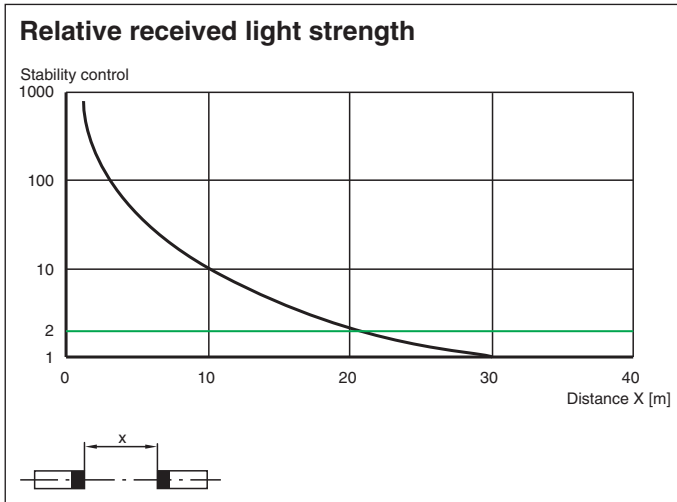





Release date: 2023-03-28 Date of issue: 2023-03-28 Filename: 70132093_eng.pdf

Characteristic Curve



Accessories

	OMH-ML100-S2	Mounting aid for ML100 series, mounting bracket
	OMH-ML100-09	Mounting aid for round steel \varnothing 12 mm or sheet 1.5 mm ... 3 mm
	OMH-ML100-01	Mounting aid for ML100 series, mounting bracket
	OMH-ML100-02	Mounting aid for ML100 series, mounting bracket
	OMH-ML100-03	Mounting aid for round steel \varnothing 12 mm or sheet 1.5 mm ... 3 mm
	OMH-ML100-04	Mounting aid for ML100 series, mounting bracket
	OMH-ML100-05	Mounting aid for ML100 series, mounting bracket
	OMH-F10-ML100	Mounting aid for ML100 series
	OMH-10	Mounting aid for ML100 series
	OMH-ML100-S1	Mounting bracket

Release date: 2023-03-28 Date of issue: 2023-03-28 Filename: 70132093_eng.pdf