

## Female cordset

### V3-WM-E2-OR1M-PUR-A1

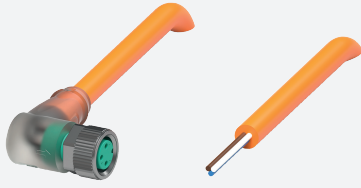

- Improved resistance to weld slag
- Suitable for drag chains and abrasion resistant
- Suitable for robotic applications / torsion resistant
- Built-in LED, as operating and function indicator
- Degree of protection IP68
- Free of paint wetting interfering substances
- Resistant to microbes and hydrolysis
- UL listed for USA and Canada
- Halogen-free
- Meets the VASS6 standard
- Specific design protects against loosening and inaccurate installation

Female cordset single-ended M8 angled A-coded, LED 3-pin, PUR cable welding-bead resistant orange, UL approved, drag chain suitable, torsion resistant



## Dimensions

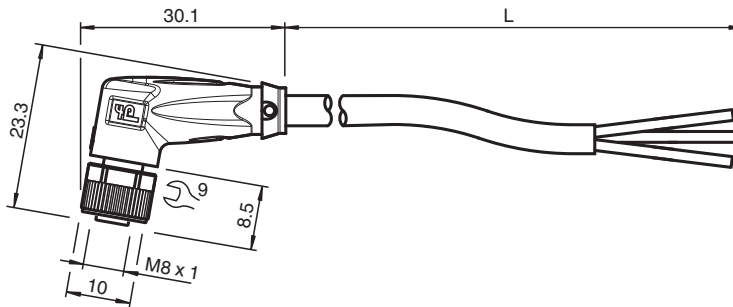

## Technical Data

### General specifications

Connector 1	
Connection	socket
Construction type	M8
Style	angled
Locking	screw connection
Number of pins	3
Coding	A-coded
Connector 2	
Connection	cable end

### Indicators/operating means

LED green	Operating display
LED yellow	Functional display pin 4

### Electrical specifications

Operating voltage	$U_B$	max. 24 V DC -20 % / +25 %
Operating current	$I_B$	max. 4 A

### Conformity

Degree of protection	EN 60529
Plug connection	connector M8 x 1 : IEC 61076-2-104

Release date: 2023-09-04 Date of issue: 2023-09-04 Filename: 70137360-100005\_eng.pdf

Refer to "General Notes Relating to Pepperl+Fuchs Product Information".

Pepperl+Fuchs Group  
www.pepperl-fuchs.com

USA: +1 330 486 0001  
fa-info@us.pepperl-fuchs.com

Germany: +49 621 776 1111  
fa-info@de.pepperl-fuchs.com

Singapore: +65 6779 9091  
fa-info@sg.pepperl-fuchs.com

**PF** PEPPERL+FUCHS

## Technical Data

Flammability		UL 1581; DIN EN 60332-2-2
PWIS conformity		VW-PV 3.10.7
Halogen-free		DIN VDE 0472-815
Oil resistance		DIN EN 60811-2-1
<b>Approvals and certificates</b>		
UL approval		AWM STYLE 20549 AWM I/II A/B 80°C 300V FT2 (cable)
UL File Number		E231213
<b>Ambient conditions</b>		
Ambient temperature		
Plug connector		-40 ... 90 °C (-40 ... 194 °F)
Cable, fixed		-40 ... 80 °C (-40 ... 176 °F)
Cable, flexing		-25 ... 80 °C (-13 ... 176 °F)
Pollution degree		3
<b>Mechanical specifications</b>		
Plug connector		
Tightening torque		0.4 Nm
Loosening protection		available
Tool installation		straight knurling and hexagon nut SW = 9 mm
Mating cycles		min. 100
Degree of protection		IP68
Cable		
Sheath diameter		4.9 mm
Bending radius		> 10 x cable diameter, moving > 5 x cable diameter, fixed
Sheath stripping force		max. 80 N / 300 mm
Sheath color		orange (similar to RAL 2003)
Number of cores		3
Core cross section		0.34 mm <sup>2</sup>
Coors color		Core 1: brown Core 2: not used Core 3: blue Core 4: black
Core construction		42 x 0.1 mm Ø
Length	L	1 m
Cable code		Li F 9Y 11Y 4 x 0,34
Drag chain suitability		
Drag chain cycles		min. 5000000
Motion velocity		max. 3 m/s
Traverse distance		max. 5 m
Acceleration		max. 5 m/s <sup>2</sup>
Torsion cycles		min. 1000000
Torsional stress		± 180 °/m
<b>Material</b>		
PWIS free		yes
Halogen-free		yes
Plug connector		
Screw connection		Zinc diecast, nickel-plated
Body		TPU, transparent
Seal		FKM
Contact surface		gold plated (Au)
Flammability		V-2
Cable		
Sheathing		PUR based on polyether
Core insulation		PP

Release date: 2023-09-04 Date of issue: 2023-09-04 Filename: 70137360-100005\_eng.pdf

Refer to "General Notes Relating to Pepperl+Fuchs Product Information".

Pepperl+Fuchs Group  
www.pepperl-fuchs.comUSA: +1 330 486 0001  
fa-info@us.pepperl-fuchs.comGermany: +49 621 776 1111  
fa-info@de.pepperl-fuchs.comSingapore: +65 6779 9091  
fa-info@sg.pepperl-fuchs.com

**PEPPERL+FUCHS**



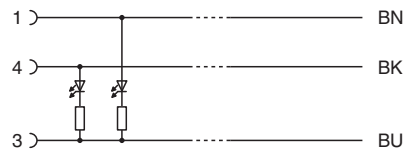
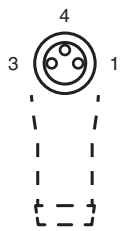

## Technical Data

Welding-bead resistance	yes
Weld spatter resistance	yes
Chemical resistance	good
Oil resistance	yes
Cooling lubricant resistance	yes
Microbial resistance	yes
Hydrolysis resistance	yes
Flammability	FT2

## Connection



## Accessories

	<b>MH V3-SCREWDRIVER</b>	Torque screwdriver (0.4 Nm)
	<b>MH V3-BIT M8</b>	plug-in cap for M8
	<b>V1/V3-LABELHOLDER</b>	Label holder
	<b>V1/V3-LABEL</b>	Label plate
	<b>MH V3-Holder</b>	Modular universal holder for M8 connectors

Release date: 2023-09-04 Date of issue: 2023-09-04 Filename: 70137360-100005\_eng.pdf