

Mounting adapter

MONAD-M08-1,25-M20-2,5/368

- Usable for VIM3* / VIM6* vibration sensors with external thread
- Usable for VIM8* vibration sensors
- Robust due to stainless steel 1.4404 / AISI 316L (V4A)
- Screw-in thread for simple installation

Mounting adapter for VIM3*/VIM6*/VIM8* vibration sensors, internal thread M8 x 1.25 x 10, external thread M20 x 2.5, screw-in depth 34

Dimensions

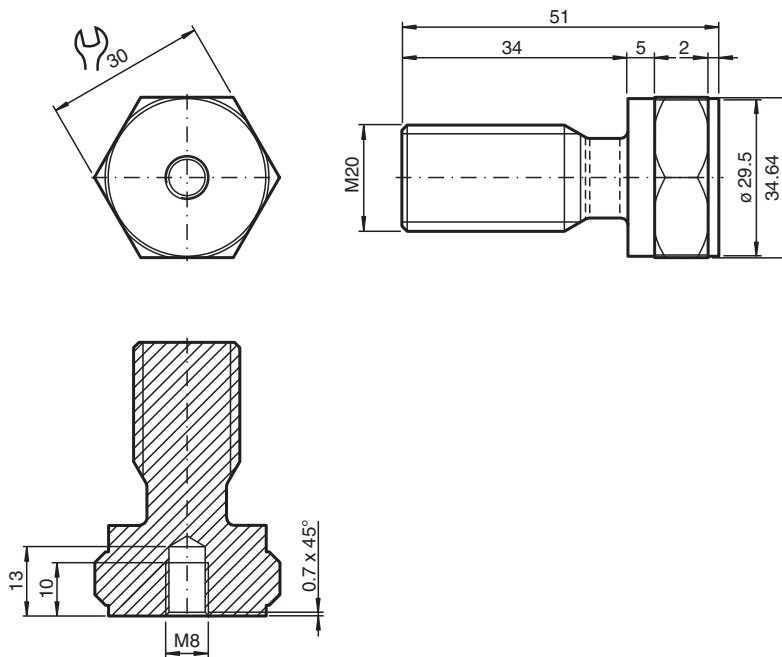

Technical Data

General specifications

Suitable components	VIM3* vibration sensors VIM6* vibration sensors VIM8* vibration sensors
---------------------	---

Mechanical specifications

External thread	for machine mounting
Thread type	metric
Thread size	M20 x 2.5
Screw-in depth	34 mm
Internal thread	for sensor mounting

Technical Data

Thread type		metric
Thread size		M8 x 1.25
Thread length		10 mm
Length	L	51 mm
Diameter		34.64 mm
Material		Stainless steel 1.4404 / AISI 316L
Mass		165 g

Release date: 2023-05-11 Date of issue: 2023-05-11 Filename: 70146790_eng.pdf

Refer to "General Notes Relating to Pepperl+Fuchs Product Information".

Pepperl+Fuchs Group
www.pepperl-fuchs.com

USA: +1 330 486 0001
fa-info@us.pepperl-fuchs.com

Germany: +49 621 776 1111
fa-info@de.pepperl-fuchs.com

Singapore: +65 6779 9091
fa-info@sg.pepperl-fuchs.com