



Fault Status Module

M-LB-4400

- Two-part monitoring device
- Device set with transmitter/receiver and reverse unit
- Fault indication via LED
- Status indication output



Function

The fault status module monitors the status of several surge protection barriers. The device set consists of 2 parts, the visual transmitter/receiver and the visual reverse unit. The device has a status indication at the front. The status indication is transmitted to the control via the remote signalling contact. The status indication output is performed as normally-closed contact. The device is mounted on a 35 mm DIN mounting rail according to EN 60715.

Connection

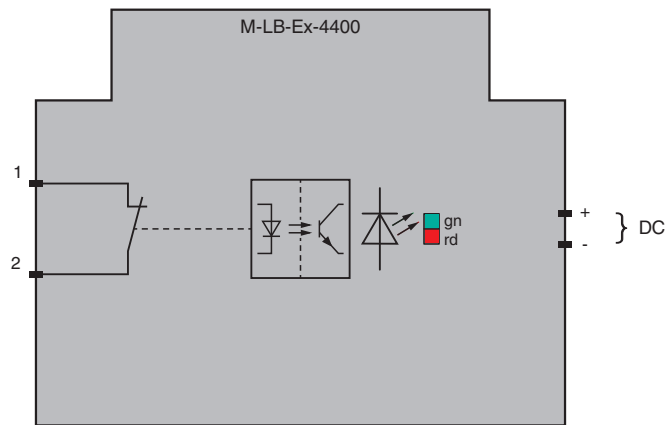

Zone 2

Technical Data

Input	
Voltage range	6 ... 35 V DC
Rated current	$I_r \leq 10 \text{ mA}$
Output	
Connection	terminals 11, 12
Switching power	48 V DC/500 mA/ $P_{max} 300 \text{ mW}$
Output	signal ; remote signalling contact (NC contact)
Leakage current	< 1 μA
Resistor	contact resistance : < 2.5 Ω
Test cycle	continuous
Indicators/settings	

Release date: 2023-06-20 Date of issue: 2023-06-20 Filename: 70155100_eng.pdf

Refer to "General Notes Relating to Pepperl+Fuchs Product Information".

Pepperl+Fuchs Group
www.pepperl-fuchs.com

USA: +1 330 486 0002
pa-info@us.pepperl-fuchs.com

Germany: +49 621 776 2222
pa-info@de.pepperl-fuchs.com

Singapore: +65 6779 9091
pa-info@sg.pepperl-fuchs.com

PF PEPPERL+FUCHS

Technical Data

Display elements	status display operating state (green) fault indication (red)
Directive conformity	
Electromagnetic compatibility	
Directive 2014/30/EU	EN 61326-1:2013 (industrial locations)
Conformity	
Degree of protection	IEC 60529:2013
Functional safety	IEC/EN 61508:2010
Ambient conditions	
Ambient temperature	-30 ... 70 °C (-22 ... 158 °F)
Storage temperature	-30 ... 70 °C (-22 ... 158 °F)
Relative humidity	max. 95 % , without condensation
Corrosion resistance	acc. to ISA-S71.04, severity level G3
Mechanical specifications	
Degree of protection	IP20
Connection	spring terminals with push-in connection technology
Core cross section	0.2 ... 2.5 mm ² one wire 0.2 ... 2.5 mm ² fine-strand
Material	
Housing	Polyamide PA 6.6
Mass	approx. 52 g
Dimensions	6 x 90 x 69 mm (0.24 x 3.5 x 2.7 inch) (W x H x D)
Mounting	on 35 mm DIN mounting rail acc. to EN 60715:2001
Data for application in connection with hazardous areas	
Certificate	TÜV 22 ATEX 8882 X
Marking	Ⓜ II 3G Ex ec IIC T4 Gc
Directive conformity	
Directive 2014/34/EU	EN 60079-0:2018 , EN IEC 60079-7:2015+A1:2018
International approvals	
UL approval	E223772
IECEX approval	
IECEX certificate	IECEX TUR 22.0052X
IECEX marking	Ex ec IIC T4 Gc
General information	
Supplementary information	Observe the certificates, declarations of conformity, instruction manuals, and manuals where applicable. For information see www.pepperl-fuchs.com .

Release date: 2023-06-20 Date of issue: 2023-06-20 Filename: 70155100_eng.pdf







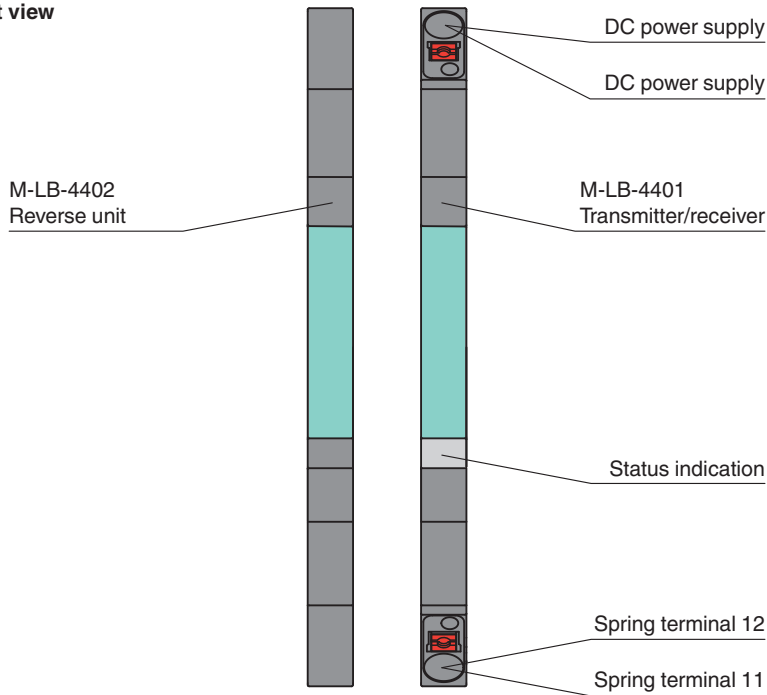



Refer to "General Notes Relating to Pepperl+Fuchs Product Information".

Assembly

Front view



Matching System Components

	M-LB-4272	Surge Protection Barrier
	M-LB-4282	Surge Protection Barrier
	M-LB-4252	Surge Protection Barrier
	M-LB-4222	Surge Protection Barrier
	M-LB-4254	Surge Protection Barrier
	M-LB-4224	Surge Protection Barrier
	M-LB-4212	Surge Protection Barrier
	M-LB-4214	Surge Protection Barrier
	M-LB-4242	Surge Protection Barrier
	M-LB-4244	Surge Protection Barrier
	M-LB-Ex-4242	Surge Protection Barrier

Release date: 2023-06-20 Date of issue: 2023-06-20 Filename: 70155100_eng.pdf

Refer to "General Notes Relating to Pepperl+Fuchs Product Information".

Matching System Components



M-LB-4800

Separation Wall

Release date: 2023-06-20 Date of issue: 2023-06-20 Filename: 70155100_eng.pdf

Refer to "General Notes Relating to Pepperl+Fuchs Product Information".

Pepperl+Fuchs Group
www.pepperl-fuchs.com

USA: +1 330 486 0002
pa-info@us.pepperl-fuchs.com

Germany: +49 621 776 2222
pa-info@de.pepperl-fuchs.com

Singapore: +65 6779 9091
pa-info@sg.pepperl-fuchs.com