

RFID Transponder

IUC87-F257-T19-M-FR2 10 pcs



- Operating frequency 902 ... 928 MHz
- Complies with EPC Gen2 (ISO/IEC 18000-63)
- Sturdy housing, suitable for rough industrial use
- Optimized for mounting on metal
- For autoclave applications

Tag for autoclave applications



Dimensions

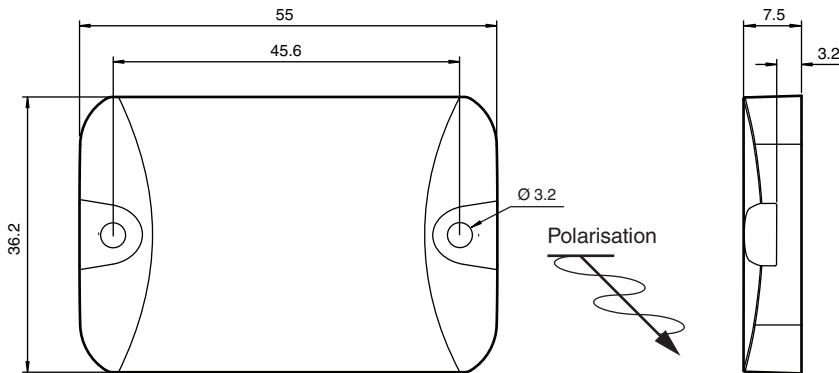

Technical Data

General specifications	
Operating frequency	902 ... 928 MHz
Polarization	linear
Memory	
Chip Type	Higgs-9 (Alien)
Memory Bank 00 (Reserved)	64 Bit
Memory Bank 01 (EPC/UII)	96 ... 496 Bit
Memory Bank 10 (TID)	48 Bit
Memory Bank 11 (User memory)	688 Bit
Read cycles	unlimited
Write cycles	200000
Data retention period	50 years
Directive conformity	
Radio equipment	
Directive 2014/53/EU	EN 302208
RoHS	
Directive 2011/65/EU (RoHS)	IEC/EN 63000

Release date: 2022-11-28 Date of issue: 2022-11-29 Filename: 70155465_eng.pdf

Refer to "General Notes Relating to Pepperl+Fuchs Product Information".

Pepperl+Fuchs Group
www.pepperl-fuchs.com

USA: +1 330 486 0001
fa-info@us.pepperl-fuchs.com

Germany: +49 621 776 1111
fa-info@de.pepperl-fuchs.com

Singapore: +65 6779 9091
fa-info@sg.pepperl-fuchs.com

PEPPERL+FUCHS

Technical Data

Standard conformity	
Degree of protection	EN 60529
RFID	ISO/IEC 18000-63
Ambient conditions	
Ambient temperature	-40 ... 85 °C (-40 ... 185 °F)
Storage temperature	-40 ... 150 °C (-40 ... 302 °F) 150 °C for 600 hours
Shock and impact resistance	1 m (3 ft) on concrete
Mechanical specifications	
Housing length	55 mm
Housing width	36.2 mm
Housing height	7.5 mm
Degree of protection	IP69K
Material	
Housing	Polymer , 316L Stainless steel , Silicone seal
Installation	
On metal	yes
Mass	26 g
Construction type	Rectangular type
Note	Packaging unit, 10-piece

Mounting

High temperatures will cause the housing to expand.
If the housing is assembled under mechanical stress, the resulting pressure may damage the tag.
Install the tag loosely to allow for expansion due to high temperatures.