



Connection cable, shielded V112-G-BK1M-PUR-ABG-V112-W

- Suitable for drag chains and abrasion resistant
- Degree of protection IP65 / IP67
- Resistant to microbes and hydrolysis
- Halogen-free
- Immunity to vibration, with mechanical latching
- Knurled nut suitable for tool assembly

Cordset M12 socket straight to M12 plug angled A-coded, 12-pin, PUR cable black, shielded, drag chain suitable



Dimensions

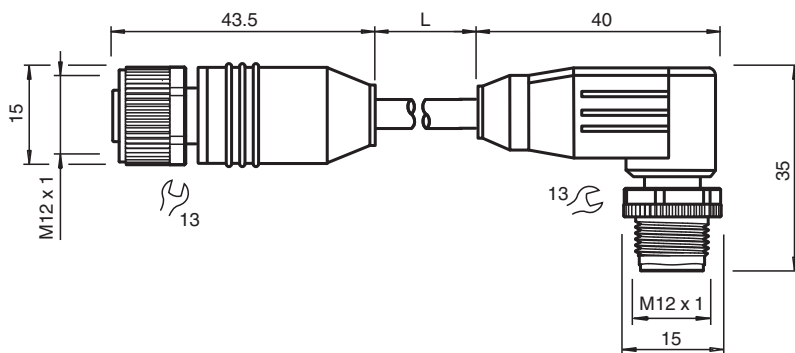

Technical Data

General specifications

Connector 1	
Connection	socket
Construction type	M12
Style	straight
Locking	screw connection
Number of pins	12
Coding	A-coded
Connector 2	
Connection	plug
Construction type	M12
Style	angled
Locking	screw connection
Number of pins	12
Coding	A-coded

Electrical specifications

Release date: 2023-06-16 Date of issue: 2023-06-16 Filename: 70155693_eng.pdf

Refer to "General Notes Relating to Pepperl+Fuchs Product Information".

Pepperl+Fuchs Group
www.pepperl-fuchs.com

USA: +1 330 486 0001
fa-info@us.pepperl-fuchs.com

Germany: +49 621 776 1111
fa-info@de.pepperl-fuchs.com

Singapore: +65 6779 9091
fa-info@sg.pepperl-fuchs.com

 **PEPPERL+FUCHS**

Technical Data

Operating voltage	U _B	max. 30 V AC/DC
Operating current	I _B	max. 1.5 A
Conformity		
Degree of protection		EN 60529
Plug connection		connector M12 x 1 : IEC 61076-2-101
Flammability		UL 1581; DIN EN 60332-2-2
Microbial resistance		EN 50396 / DIN VDE 0282-10
Hydrolysis resistance		EN 50396 / DIN VDE 0282-10
Oil resistance		DIN EN 60811-404
Ambient conditions		
Ambient temperature		
Plug connector		-25 ... 85 °C (-13 ... 185 °F)
Cable, fixed		-40 ... 80 °C (-40 ... 176 °F)
Cable, flexing		-25 ... 80 °C (-13 ... 176 °F)
Pollution degree		3
Mechanical specifications		
Plug connector		
Tightening torque		0.6 Nm
Loosening protection		available
Tool installation		straight knurling and hexagon nut SW = 13 mm
Mating cycles		min. 100
Shielding		shield connected to screw connection
Degree of protection		IP65/IP67
Cable		according to IEC/EN 60228 (DIN VDE 0295) class 6
Sheath diameter		6.5 mm
Bending radius		> 10 x cable diameter, moving > 5 x cable diameter, fixed
Sheath color		black (similar to RAL 9005)
Number of cores		12
Core cross section		0.14 mm ²
Cores color		Core 1: brown Core 2: blue Core 3: white Core 4: green Core 5: pink Core 6: yellow Core 7: black Core 8: grey Core 9: red Core 10: violet Core 11: grey/pink Core 12: red/blue
Core construction		18 x 0.1 mm Ø
Shield		tinned copper braiding, 80 % coverage
Length	L	1 m
Cable code		LSPYwC11Y
Drag chain suitability		
Drag chain cycles		max. 5000000
Motion velocity		max. 3.3 m/s
Acceleration		max. 5 m/s ²
Torsion cycles		max. 2000000
Torsional stress		± 30 °/m
Material		
Halogen-free		yes
Plug connector		
Screw connection		Zinc diecast, nickel-plated
Body		PUR, black

Release date: 2023-06-16 Date of issue: 2023-06-16 Filename: 70155693_eng.pdf





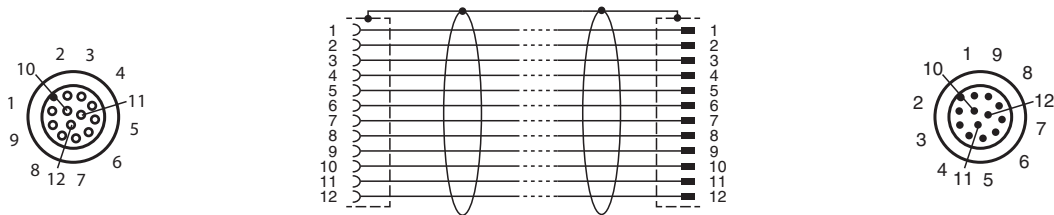

Technical Data

Seal	FKM
Contact surface	gold plated (Au)
Flammability	V-0
Cable	
Sheathing	PUR
Core insulation	PP
Chemical resistance	good
Oil resistance	yes
Microbial resistance	yes
Hydrolysis resistance	yes
Flammability	FT2

Connection Assignment



Accessories

	MH V1-SCREWDRIVER	Torque screwdriver (0.6 Nm)
	MH V1-BIT M12	plug-in cap M12
	V1/V3-LABELHOLDER	Label holder
	V1/V3-LABEL	Label plate
	MH V1-Holder	Modular universal holder for M12 connectors
	V1-CLIP	Unlocking protector for M12 connector
	V1-MARKING-RING-COLOR	Marking rings for M12 connectors, various colors

Release date: 2023-06-16 Date of issue: 2023-06-16 Filename: 70155693_eng.pdf