

## Connection cable, Ethernet V1SD-W-GN5M-PUR-E2S-V45-G

- Hard-wearing PUR cable
- Industrial Ethernet
- D coding for Ethernet
- CAT5/CAT5e cable
- Degree of protection IP68 / IP69
- Free of paint wetting interfering substances
- Halogen-free
- Specific design protects against loosening and inaccurate installation

Ethernet bus cable M12 plug angled D-coded to RJ45 Ethernet-coded, 4-pin, PUR cable green, Cat5e, shielded



### Dimensions

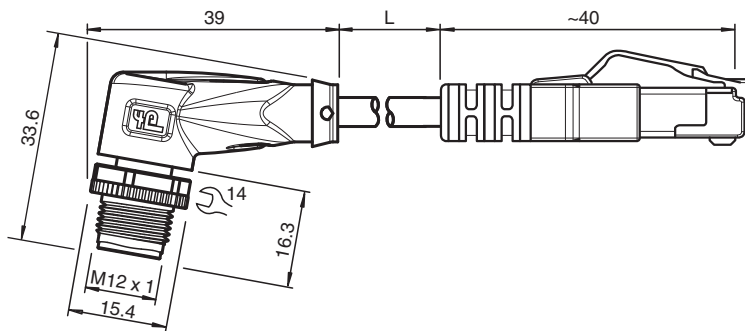

### Technical Data

#### General specifications

<b>Connector 1</b>	
Connection	plug
Construction type	M12
Style	angled
Locking	screw connection
Number of pins	4
Coding	D-coded
<b>Connector 2</b>	
Connection	plug
Construction type	RJ45
Style	straight
Locking	snap locking
Number of pins	8
Coding	EtherNet/IP

#### Electrical specifications

Release date: 2024-03-17 Date of issue: 2024-03-17 Filename: 70165005\_eng.pdf

Refer to "General Notes Relating to Pepperl+Fuchs Product Information".

Pepperl+Fuchs Group  
www.pepperl-fuchs.com

USA: +1 330 486 0001  
fa-info@us.pepperl-fuchs.com

Germany: +49 621 776 1111  
fa-info@de.pepperl-fuchs.com

Singapore: +65 6779 9091  
fa-info@sg.pepperl-fuchs.com

PEPPERL+FUCHS

## Technical Data

Operating voltage	U <sub>B</sub>	max. 48 V AC / 60 V DC
Rated current	I <sub>r</sub>	max. 1 A
<b>Conformity</b>		
Degree of protection		EN 60529
Plug connection		connector M12 x 1 : IEC 61076-2-101 connector RJ45 : IEC 60603-7
Component category		CAT5 (IEC 11801) , CAT5e (IEC 61156-6)
Flammability		IEC 60332-1-2 / UL 1581 / ISO 6722-1 5.22 (UN ECE-R 118.01)
Halogen-free		IEC 60754-1
Chemical resistance		DIN EN 60811-2-1
Microbial resistance		DIN EN 50525-2-21 / DIN VDE 0282-10
Oil resistance		DIN EN 60811-2-1
<b>Ambient conditions</b>		
Ambient temperature		
Connector 1		-40 ... 90 °C (-40 ... 194 °F)
Cable, fixed		-40 ... 80 °C (-40 ... 176 °F)
Cable, flexing		-30 ... 70 °C (-22 ... 158 °F)
<b>Mechanical specifications</b>		
Connector 1		
Tightening torque		0.6 Nm
Loosening protection		available
Tool installation		straight knurling and hexagon nut SW = 14 mm
Mating cycles		min. 100
Shielding		shield connected to screw connection
Degree of protection		IP68 / IP69
Connector 2		
Loosening protection		available
Mating cycles		min. 100
Shielding		shield connected to connector
Degree of protection		IP20
Cable		
Sheath diameter		4.9 mm
Bending radius		> 12 x cable diameter, moving > 6 x cable diameter, fixed
Sheath stripping force		max. 50 N / 100 mm
Sheath color		green (similar to RAL 6018)
Number of cores		4
Core cross section		0.15 mm <sup>2</sup> / 26 AWG
Cores color		Core 1-1: white/orange Core 2-3: white/green Core 3-2: orange Core 4-6: green
Core construction		19 x 0.1 mm Ø twisted quad
Shield		aluminum-lined polyester foil Tinned copper braiding, 85 % coverage
Length	L	5 m
Cable code		Li 9Y 11YM 4 x 0,15
Drag chain suitability		
Drag chain cycles		max. 1000000
Motion velocity		max. 3 m/s
Traverse distance		max. 4.5 m
Acceleration		max. 3 m/s <sup>2</sup>
<b>Material</b>		
PWIS free		yes
Halogen-free		yes

Release date: 2024-03-17 Date of issue: 2024-03-17 Filename: 70165005\_eng.pdf

Refer to "General Notes Relating to Pepperl+Fuchs Product Information".

Pepperl+Fuchs Group  
www.pepperl-fuchs.comUSA: +1 330 486 0001  
fa-info@us.pepperl-fuchs.comGermany: +49 621 776 1111  
fa-info@de.pepperl-fuchs.comSingapore: +65 6779 9091  
fa-info@sg.pepperl-fuchs.com

**PEPPERL+FUCHS**

## Technical Data

Connector 1	
Screw connection	Zinc diecast, nickel-plated
Body	TPU, black
Contact surface	Au
Flammability	V-2
Connector 2	
Body	PA, green
Flammability	V-0
Cable	
Sheathing	PUR based on polyether
Core insulation	PP
Flammability	FT1 complies with UN ECE-R 118.01

## Connection Assignment

