



# SMART Transmitter Power Supply/SMART Current Driver

## KCD2-SCS-Ex2.SP

- 2-channel isolated barrier
- 24 V DC supply (Power Rail)
- Analog input (AI), Analog output (AO)
- Operates as transmitter power supply or current driver
- Housing width 12.5 mm
- Connection via spring terminals with push-in connection technology
- Up to SIL 2 (SC 3) acc. to IEC/EN 61508



### Function

This isolated barrier is used for intrinsic safety applications. Each device channel works as a transmitter power supply or a current driver. The device transfers data by using a current signal. The device supports a bi-directional communication for SMART devices that use current modulation to transmit data and voltage modulation to receive data. For current driver operation, an open field circuit presents a high impedance to the control side to allow lead breakage to be monitored by control systems.

### Connection

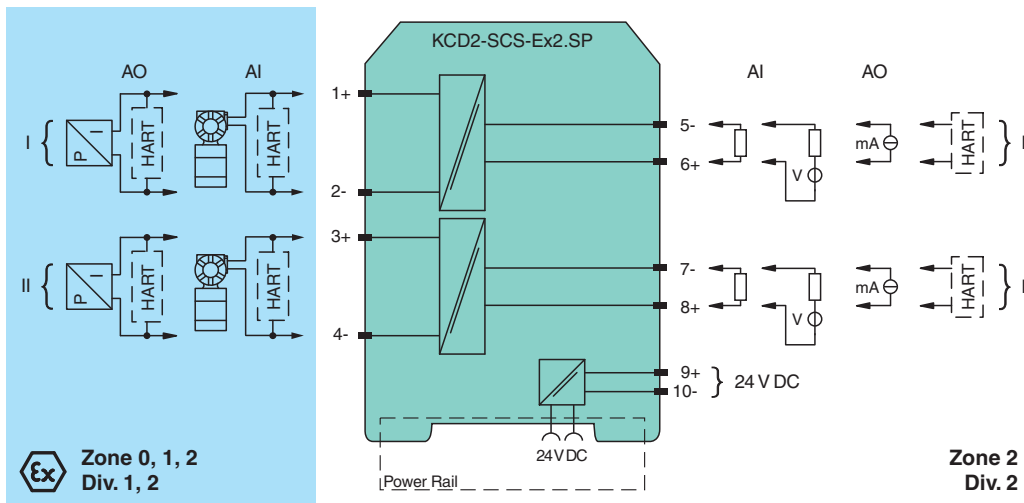

### Technical Data

General specifications	
Signal type	Analog input/analog output
Functional safety related parameters	
Safety Integrity Level (SIL)	SIL 2
Systematic capability (SC)	SC 3
Supply	
Connection	Power Rail or terminals 9+, 10-
Rated voltage	$U_r$ 19 ... 30 V DC
Ripple	max. 10 %
Rated current	$I_r$ max. 88 mA at 24 V

Release date: 2023-08-10 Date of issue: 2023-08-10 Filename: 70166764\_eng.pdf

Refer to "General Notes Relating to Pepperl+Fuchs Product Information".

Pepperl+Fuchs Group  
www.pepperl-fuchs.com

USA: +1 330 486 0002  
pa-info@us.pepperl-fuchs.com

Germany: +49 621 776 2222  
pa-info@de.pepperl-fuchs.com

Singapore: +65 6779 9091  
pa-info@sg.pepperl-fuchs.com



## Technical Data

Power dissipation		max. 1.4 W
Power consumption		max. 2.1 W
<b>Analog input</b>		
Number of channels		2
Suitable field devices		2-wire SMART transmitters
Signal		0/4 ... 20 mA , limited to approx. 30 mA
<b>Field circuit</b>		terminals 1+, 2-, 3+, 4-
Available voltage		min. 15 V at 20 mA min. 18 V at 4 mA
<b>Control circuit</b>		terminals 5-, 6+; 7-, 8+ limited electrical values : max. 30 V , max. 2 A
Input voltage		Voltage across terminals 10 ... 30 V. If the current is supplied from a source > 24 V, series resistance of $\geq (V - 24)/0.02 \Omega$ is needed, where V is the source voltage. The maximum value of the resistance is $(V - 10)/0.02 \Omega$ . (sink output)
Load		max. 350 $\Omega$ (source output)
Ripple		20 mV <sub>eff</sub>
<b>Analog output</b>		
Number of channels		2
Suitable field devices		SMART I/P converters (positioner), on-site-displays
Signal		0/4 ... 20 mA , limited to approx. 30 mA
<b>Field circuit</b>		terminals 1+, 2-, 3+, 4-
Load		max. 650 $\Omega$
Voltage		min. 13 V at 20 mA
Ripple		20 mV <sub>eff</sub> , on all signal terminals
<b>Control circuit</b>		terminals 5-, 6+; 7-, 8+ limited electrical values : max. 30 V , max. 2 A
Voltage drop		max. 6 V
Line fault detection		> 100 k $\Omega$ at max. 30 V, with field wiring open
<b>Transfer characteristics</b>		
Deviation		max. 20 $\mu$ A incl. calibration, linearity, hysteresis, loads and fluctuations of supply voltage
Influence of ambient temperature		< 2 $\mu$ A/K (-40 ... 70 °C (-40 ... 158 °F))
Frequency range		field side into the control side: bandwidth with 0.5 V <sub>pp</sub> signal 0 ... 3 kHz (-3 dB) control side into the field side: bandwidth with 0.5 V <sub>pp</sub> signal 0 ... 3 kHz (-3 dB)
Settling time		max. 200 ms
Rise time/fall time		max. 100 ms (10 ... 90 %)
<b>Galvanic isolation</b>		
Field circuit/control circuit		basic insulation according to IEC/EN 61010-1, rated insulation voltage 300 V <sub>eff</sub>
Control circuit/control circuit		functional isolation, rated voltage: 50 V
Field circuit/power supply		reinforced insulation according to IEC/EN 61010-1, rated insulation voltage 300 V <sub>eff</sub>
Control/power supply		basic insulation according to IEC/EN 61010-1, rated insulation voltage 300 V <sub>eff</sub>
<b>Indicators/settings</b>		
Display elements		LED
Factory setting		analog input with source output
Configuration		via DIP switches
Labeling		space for labeling at the front
<b>Directive conformity</b>		
Electromagnetic compatibility		
Directive 2014/30/EU		EN 61326-1:2013 (industrial locations)
<b>Conformity</b>		
Electromagnetic compatibility		NE 21:2017 EN 61326-3-2:2018
Degree of protection		IEC 60529:2001
Protection against electrical shock		UL 61010-1:2019
<b>Ambient conditions</b>		
Ambient temperature		-40 ... 70 °C (-40 ... 158 °F)

Release date: 2023-08-10 Date of issue: 2023-08-10 Filename: 70166764\_eng.pdf

Refer to "General Notes Relating to Pepperl+Fuchs Product Information".

 Pepperl+Fuchs Group  
www.pepperl-fuchs.com

 USA: +1 330 486 0002  
pa-info@us.pepperl-fuchs.com

 Germany: +49 621 776 2222  
pa-info@de.pepperl-fuchs.com

 Singapore: +65 6779 9091  
pa-info@sg.pepperl-fuchs.com

 **PEPPERL+FUCHS**

## Technical Data

Mechanical specifications		
Degree of protection		IP20
Connection		spring terminals
Mass		approx. 115 g
Dimensions		12.5 x 124 x 114 mm (0.5 x 4.9 x 4.5 inch) (W x H x D) , housing type A2
Mounting		on 35 mm DIN mounting rail acc. to EN 60715:2001
Data for application in connection with hazardous areas		
EU-type examination certificate		UL 22 ATEX 2786 X
Marking		⊕ II (1)G [Ex ia Ga] IIC ⊕ II (1)D [Ex ia Da] IIIC ⊕ I (M1) [Ex ia Ma] I
Output		Ex ia, Ex iaD
Voltage	$U_o$	25.2 V
Current	$I_o$	100 mA
Power	$P_o$	630 mW
Internal capacitance	$C_i$	1.05 nF
Internal inductance	$L_i$	0
Supply		
Maximum safe voltage	$U_m$	250 V <sub>rms</sub> (Attention! The rated voltage can be lower.)
Input		
Maximum safe voltage	$U_m$	250 V <sub>rms</sub> (Attention! The rated voltage can be lower.)
Certificate		UL 22 ATEX 2787 X
Marking		⊕ II 3G Ex ec IIC T4 Gc [device in zone 2]
Galvanic isolation		
Field circuit/control circuit		safe electrical isolation acc. to IEC/EN 60079-11, voltage peak value 375 V
Field circuit/power supply		safe electrical isolation acc. to IEC/EN 60079-11, voltage peak value 375 V
Directive conformity		
Directive 2014/34/EU		EN IEC 60079-0:2018 , EN 60079-11:2012 , EN IEC 60079-7:2015+A1:2018
International approvals		
UL approval		E106378
Control drawing		116-0490 (cULus)
IECEX approval		
IECEX certificate		IECEX ULD 22.0020X
IECEX marking		[Ex ia Ga] IIC , [Ex ia Da] IIIC , [Ex ia Ma] I Ex ec IIC T4 Gc
General information		
Supplementary information		Observe the certificates, declarations of conformity, instruction manuals, and manuals where applicable. For information see <a href="http://www.pepperl-fuchs.com">www.pepperl-fuchs.com</a> .

Release date: 2023-08-10 Date of issue: 2023-08-10 Filename: 70166764\_eng.pdf

Refer to "General Notes Relating to Pepperl+Fuchs Product Information".





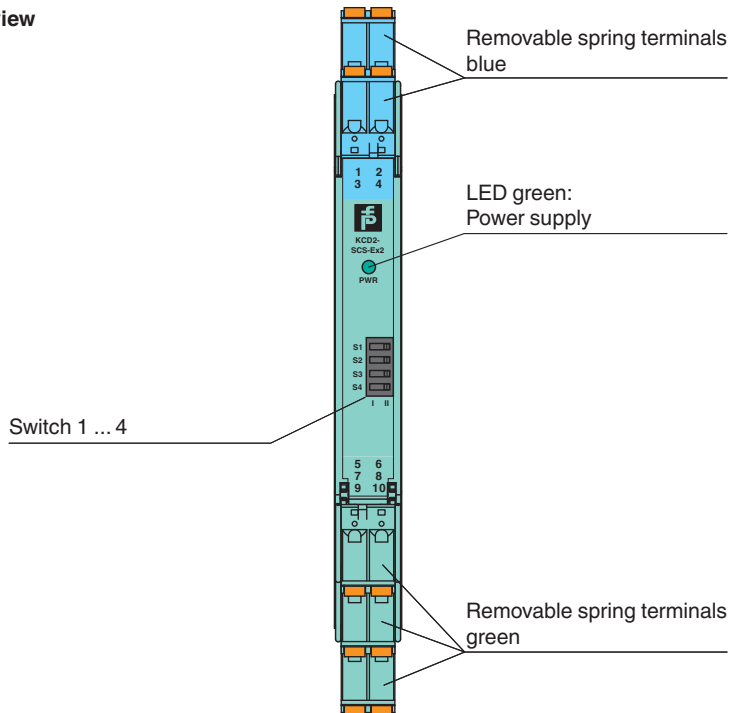

Pepperl+Fuchs Group  
[www.pepperl-fuchs.com](http://www.pepperl-fuchs.com)USA: +1 330 486 0002  
pa-info@us.pepperl-fuchs.comGermany: +49 621 776 2222  
pa-info@de.pepperl-fuchs.comSingapore: +65 6779 9091  
pa-info@sg.pepperl-fuchs.com
 PEPPERL+FUCHS

## Assembly





Front view



## Matching System Components

	<b>KFD2-EB2</b>	Power Feed Module
	<b>UPR-03</b>	Universal Power Rail with end caps and cover, 3 conductors, length: 2 m
	<b>UPR-03-M</b>	Universal Power Rail with end caps and cover, 3 conductors, length: 1,6 m
	<b>UPR-03-S</b>	Universal Power Rail with end caps and cover, 3 conductors, length: 0.8 m
	<b>K-DUCT-BU</b>	Profile rail, wiring comb field side, blue
	<b>K-DUCT-BU-UPR-03</b>	Profile rail with UPR-03- * insert, 3 conductors, wiring comb field side, blue

## Accessories

	<b>EBP 2-5</b>	Insertion bridge for connectors, 2-pin, fully insulated
	<b>KC-ST-5GN</b>	Terminal block for KC modules, 2-pin screw terminal, green
	<b>KC-ST-5BU</b>	Terminal block for KC modules, 2-pin screw terminal, blue
	<b>KF-CP</b>	Red coding pins, packaging unit: 20 x 6

Release date: 2023-08-10 Date of issue: 2023-08-10 Filename: 70166764\_eng.pdf

Refer to "General Notes Relating to Pepperl+Fuchs Product Information".

Pepperl+Fuchs Group  
www.pepperl-fuchs.com

USA: +1 330 486 0002  
pa-info@us.pepperl-fuchs.com

Germany: +49 621 776 2222  
pa-info@de.pepperl-fuchs.com

Singapore: +65 6779 9091  
pa-info@sg.pepperl-fuchs.com

 **PEPPERL+FUCHS**

**Configuration**

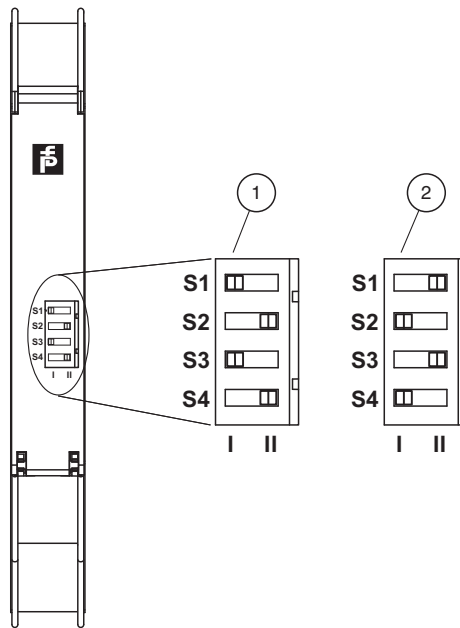

- 1 Analog input with current source output
- 2 Analog input with current sink output, analog output

**Switch position**

Function		Switch			
		Channel 1		Channel 2	
Field side	Control side	S1	S2	S3	S4
Analog input	Current source	I	II	I	II
Analog input	Current sink	II	I	II	I
Analog output		II	I	II	I

Factory setting: analog input with current source output

Release date: 2023-08-10 Date of issue: 2023-08-10 Filename: 70166764\_eng.pdf

Refer to "General Notes Relating to Pepperl+Fuchs Product Information".