

Y connection cable

V11-G-0,6M-PUR-U-T-0,6M-V31-GM

- Easy merging of two signals at a single M8 slot
- Suitable for drag chains and abrasion resistant
- Suitable for robotic applications / torsion resistant
- Degree of protection IP68
- Free of paint wetting interfering substances
- Resistant to microbes and hydrolysis
- UV resistant
- UL listed for USA and Canada
- Halogen-free
- Specific design protects against loosening and inaccurate installation

Y connection cable M8 plug straight A-coded 4-pin to 2x M12 socket straight A-coded 3-pin, 3x PUR cable black, UL approved, drag chain suitable, torsion resistant



Dimensions

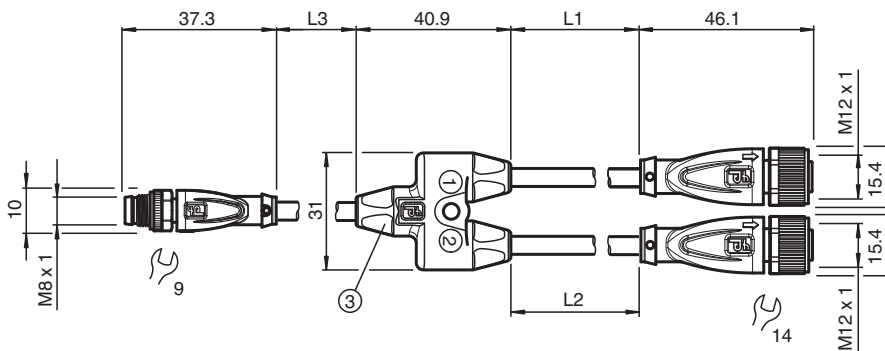

Technical Data

General specifications

| Connector 1 | |
|-------------------|------------------|
| Connection | socket |
| Construction type | M12 |
| Style | straight |
| Locking | screw connection |
| Number of pins | 3 |
| Coding | A-coded |
| Connector 2 | |
| Connection | socket |
| Construction type | M12 |
| Style | straight |
| Locking | screw connection |
| Number of pins | 3 |
| Coding | A-coded |
| Connector 3 | |
| Connection | plug |
| Construction type | M8 |
| Style | straight |

Release date: 2023-09-11 Date of issue: 2023-09-11 Filename: 70168309_eng.pdf

Refer to "General Notes Relating to Pepperl+Fuchs Product Information".

Pepperl+Fuchs Group
www.pepperl-fuchs.com

USA: +1 330 486 0001
fa-info@us.pepperl-fuchs.com

Germany: +49 621 776 1111
fa-info@de.pepperl-fuchs.com

Singapore: +65 6779 9091
fa-info@sg.pepperl-fuchs.com

PEPPERL+FUCHS

Technical Data

| | | |
|-----------------------------------|-------|---|
| Locking | | screw connection |
| Number of pins | | 4 |
| Coding | | A-coded |
| Electrical specifications | | |
| Operating voltage | U_B | max. 30 V AC/DC |
| Operating current | I_B | max. 3 A |
| Conformity | | |
| Degree of protection | | EN 60529 |
| Plug connection | | connector M12 x 1 : IEC 61076-2-101 connector M8 x 1 : IEC 61076-2-104 |
| Flammability | | UL 1581; DIN EN 60332-2-2 |
| Halogen-free | | IEC 60754-1 |
| Approvals and certificates | | |
| UL approval | | AWM STYLE 20549 AWM I/II A/B 80°C 300V FT2 (cable) |
| UL File Number | | E231213 |
| Ambient conditions | | |
| Ambient temperature | | |
| Plug connector | | -40 ... 90 °C (-40 ... 194 °F) |
| Cable, fixed | | -40 ... 80 °C (-40 ... 176 °F) |
| Cable, flexing | | -20 ... 80 °C (-4 ... 176 °F) |
| Pollution degree | | 3 |
| Mechanical specifications | | |
| Connector 1 | | |
| Tightening torque | | 0.6 Nm |
| Loosening protection | | available |
| Tool installation | | straight knurling and hexagon nut SW = 14 mm |
| Mating cycles | | min. 100 |
| Degree of protection | | IP68 / IP69 |
| Connector 2 | | |
| Tightening torque | | 0.6 Nm |
| Loosening protection | | available |
| Tool installation | | straight knurling and hexagon nut SW = 14 mm |
| Mating cycles | | min. 100 |
| Degree of protection | | IP68 / IP69 |
| Connector 3 | | |
| Tightening torque | | 0.4 Nm |
| Loosening protection | | available |
| Tool installation | | straight knurling and hexagon nut SW = 9 mm |
| Mating cycles | | min. 100 |
| Degree of protection | | IP68 |
| Cable | | |
| Sheath diameter | | 4.3 mm |
| Bending radius | | > 10 x cable diameter, moving > 5 x cable diameter, fixed |
| Sheath stripping force | | max. 80 N / 300 mm |
| Sheath color | | black (similar to RAL 9005) |
| Number of cores | | 4 |
| Core cross section | | 0.34 mm ² |
| Cores color | | Core 1: brown Core 2: white Core 3: blue Core 4: black |
| Core construction | | 42 x 0.1 mm Ø |
| Length | L | L1 = 0.6 m L2 = 0.6 m L3 = 0.6 m |

Release date: 2023-09-11 Date of issue: 2023-09-11 Filename: 70168309_eng.pdf

Refer to "General Notes Relating to Pepperl+Fuchs Product Information".

Pepperl+Fuchs Group
www.pepperl-fuchs.comUSA: +1 330 486 0001
fa-info@us.pepperl-fuchs.comGermany: +49 621 776 1111
fa-info@de.pepperl-fuchs.comSingapore: +65 6779 9091
fa-info@sg.pepperl-fuchs.com

PEPPERL+FUCHS

Technical Data

| | |
|------------------------------|-----------------------------|
| Cable code | Li 9Y 11Y 4 x 0.34 |
| Drag chain suitability | |
| Drag chain cycles | min. 5000000 |
| Motion velocity | max. 3.3 m/s |
| Traverse distance | max. 5 m |
| Acceleration | max. 5 m/s ² |
| Torsion cycles | min. 1000000 |
| Torsional stress | ± 180 °/m |
| Material | |
| PWIS free | yes |
| Halogen-free | yes |
| Plug connector | |
| Screw connection | Zinc diecast, nickel-plated |
| Body | TPU, black |
| Contact surface | gold plated (Au) |
| Flammability | V-2 |
| Cable | |
| Sheathing | PUR based on polyether |
| Core insulation | PP |
| UV resistance | yes |
| Chemical resistance | good |
| Oil resistance | yes |
| Cooling lubricant resistance | yes |
| Microbial resistance | yes |
| Hydrolysis resistance | yes |
| Flammability | FT2 |

Connection Assignment

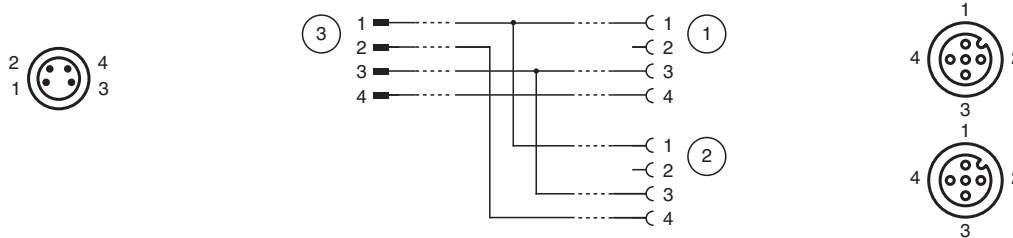







Accessories

| | | |
|--|-------------------------------|--|
| | MH Y+T-SPLITTER HOLDER | Modular universal holder for M12 T-splitter cordsets and M12 Y-splitter cordsets |
| | MH V1-SCREWDRIVER | Torque screwdriver (0.6 Nm) |
| | MH V1-BIT M12 | plug-in cap M12 |
| | MH V3-SCREWDRIVER | Torque screwdriver (0.4 Nm) |
| | MH V3-BIT M8 | plug-in cap for M8 |

Release date: 2023-09-11 Date of issue: 2023-09-11 Filename: 70168309_eng.pdf

Accessories

| | | |
|---|------------------------------|--|
|  | V1/V3-LABELHOLDER | Label holder |
|  | V1/V3-LABEL | Label plate |
|  | MH V1-Holder | Modular universal holder for M12 connectors |
|  | V1-CLIP | Unlocking protector for M12 connector |
|  | MH V3-Holder | Modular universal holder for M8 connectors |
|  | V1-MARKING-RING-COLOR | Marking rings for M12 connectors, various colors |