



## Convergent beam sensor

ML100-8-HGU-100-RT/102/115/162



- Miniature design
- Diffuse mode sensor with long, narrow light spot
- Easy to use
- Very bright, highly visible light spot
- Full metal thread mounting

Convergent mode sensor, 100 mm adjustable detection range, red light, light/dark on, NPN output, fixed cable



### Function

The optical sensors of this series are suitable for both standard and demanding applications. The series features a miniature housing design, two M3 metal-threaded mounting holes and a highly visible LED status indicator. Each device is equipped with a sensitivity adjuster and a light-on/dark-on changeover switch for increased flexibility. A wide variety of versions are available in both infrared light and red light with PowerBeam for easy alignment. Special versions with BlueBeam are suitable for challenging applications like those in the solar and battery industries.

### Dimensions

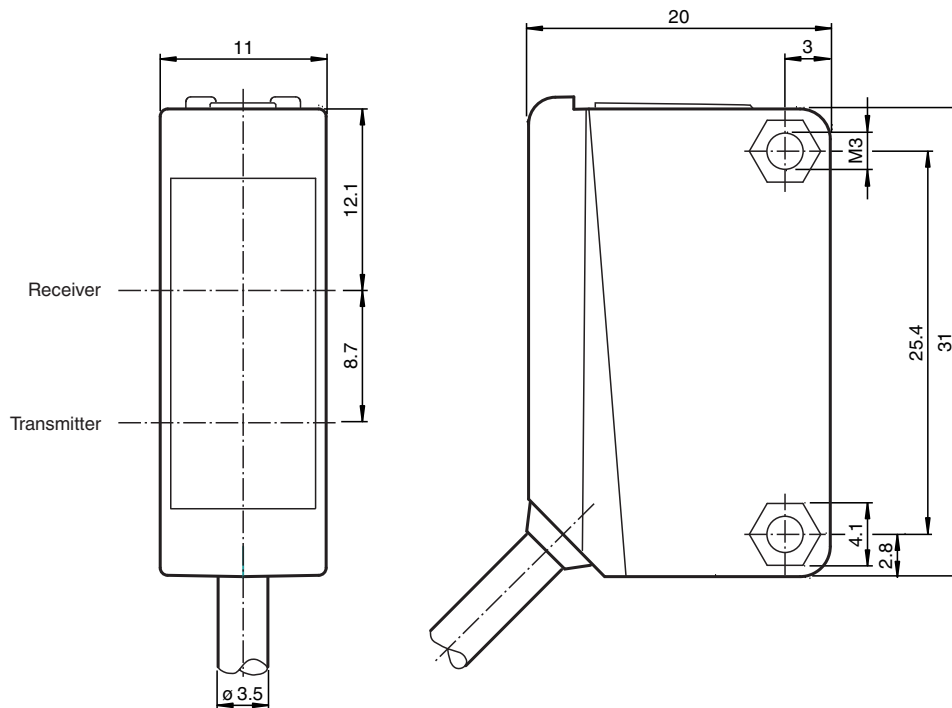

Release date: 2023-03-28 Date of issue: 2023-03-28 Filename: 815410\_eng.pdf

Refer to "General Notes Relating to Pepperl+Fuchs Product Information".

Pepperl+Fuchs Group  
www.pepperl-fuchs.com

USA: +1 330 486 0001  
fa-info@us.pepperl-fuchs.com

Germany: +49 621 776 1111  
fa-info@de.pepperl-fuchs.com

Singapore: +65 6779 9091  
fa-info@sg.pepperl-fuchs.com

**PF** PEPPERL+FUCHS

**Technical Data**

<b>General specifications</b>		
Detection range		10 ... 100 mm
Adjustment range		30 ... 100 mm
Reference target		standard black, 100 mm x 100 mm
Light source		LED
Light type		modulated visible red light
Polarization filter		no
Diameter of the light spot		approx. 6 mm x 60 mm at 100 mm
Opening angle		Emitter: 3.5 ° vertical ; 30 ° horizontal
Optical face		frontal
Ambient light limit		EN 60947-5-2:2007+A1:2012
<b>Functional safety related parameters</b>		
MTTF <sub>d</sub>		860 a
Mission Time (T <sub>M</sub> )		20 a
Diagnostic Coverage (DC)		0 %
<b>Indicators/operating means</b>		
Operation indicator		LED green: power on
Function indicator		LED yellow: lights when object is detected
Control elements		Sensing range adjuster
Control elements		Light-on/dark-on changeover switch
<b>Electrical specifications</b>		
Operating voltage	U <sub>B</sub>	10 ... 30 V DC
Ripple		max. 10 %
No-load supply current	I <sub>0</sub>	< 20 mA
<b>Output</b>		
Switching type		The switching type of the sensor is adjustable. The default setting is: light-on
Signal output		1 NPN output, short-circuit protected, reverse polarity protected, open collector
Switching voltage		max. 30 V DC
Switching current		max. 100 mA , resistive load
Voltage drop	U <sub>d</sub>	≤ 1.5 V DC
Switching frequency	f	500 Hz
Response time		1 ms
<b>Conformity</b>		
Product standard		EN 60947-5-2
<b>Approvals and certificates</b>		
UL approval		cULus Listed, Class 2 Power Source or listed Power Supply with a limited voltage output with (maybe integrated) fuse (max. 3.3 A according UL248), Type 1 enclosure
CCC approval		CCC approval / marking not required for products rated ≤36 V
<b>Ambient conditions</b>		
Ambient temperature		-30 ... 60 °C (-22 ... 140 °F)
Storage temperature		-40 ... 70 °C (-40 ... 158 °F)
<b>Mechanical specifications</b>		
Housing width		11 mm
Housing height		31 mm
Housing depth		20 mm
Degree of protection		IP67
Connection		2 m fixed cable
Material		
Housing		PC (Polycarbonate)
Optical face		PMMA
Mass		approx. 50 g
Tightening torque, fastening screws		0.6 Nm
Cable length		2 m

Release date: 2023-03-28 Date of issue: 2023-03-28 Filename: 815410\_eng.pdf

Refer to "General Notes Relating to Pepperl+Fuchs Product Information".

**Connection**

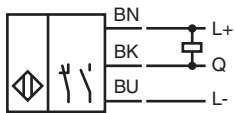

**Assembly**

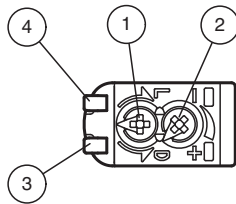

1	Light-Dark-switching	
2	Sensitivity adjuster	
3	Signal display	yellow
4	Operating display	green



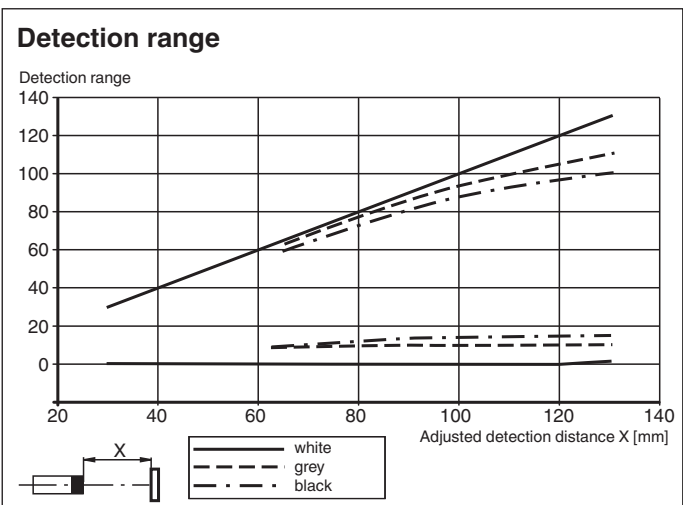
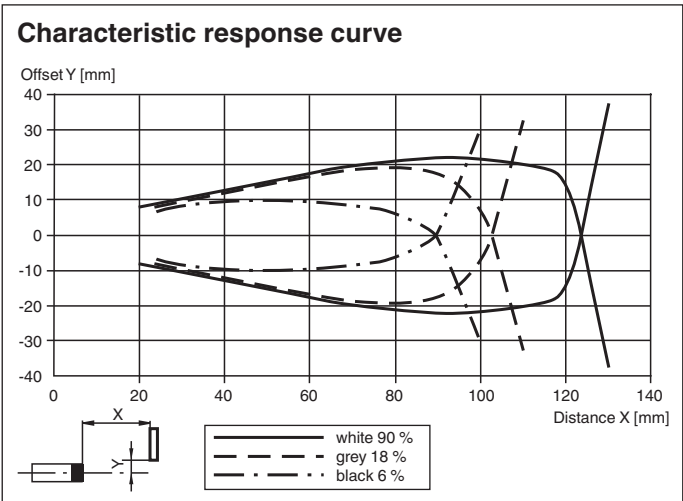





**Characteristic Curve**



Release date: 2023-03-28 Date of issue: 2023-03-28 Filename: 815410\_eng.pdf

Refer to "General Notes Relating to Pepperl+Fuchs Product Information".

**Accessories**

	<b>OMH-ML100-09</b>	Mounting aid for round steel ø 12 mm or sheet 1.5 mm ... 3 mm
	<b>OMH-ML100-01</b>	Mounting aid for ML100 series, mounting bracket
	<b>OMH-ML100-02</b>	Mounting aid for ML100 series, mounting bracket
	<b>OMH-ML100-03</b>	Mounting aid for round steel ø 12 mm or sheet 1.5 mm ... 3 mm
	<b>OMH-ML100-04</b>	Mounting aid for ML100 series, mounting bracket
	<b>OMH-ML100-05</b>	Mounting aid for ML100 series, mounting bracket
	<b>OMH-F10-ML100</b>	Mounting aid for ML100 series
	<b>OMH-10</b>	Mounting aid for ML100 series
	<b>OMH-ML100-S1</b>	Mounting bracket

Release date: 2023-03-28 Date of issue: 2023-03-28 Filename: 815410\_eng.pdf

Refer to "General Notes Relating to Pepperl+Fuchs Product Information".

Pepperl+Fuchs Group  
www.pepperl-fuchs.com

USA: +1 330 486 0001  
fa-info@us.pepperl-fuchs.com

Germany: +49 621 776 1111  
fa-info@de.pepperl-fuchs.com

Singapore: +65 6779 9091  
fa-info@sg.pepperl-fuchs.com