



Convergent beam sensor

ML100-8-HGU-100-IR/103/115/162



- Miniature design
- Diffuse mode sensor with long, narrow light spot
- Easy to use
- Full metal thread mounting

Convergent mode sensor, 100 mm adjustable detection range, infrared light, light/dark on, PNP output, fixed cable



Function

The optical sensors of this series are suitable for both standard and demanding applications. The series features a miniature housing design, two M3 metal-threaded mounting holes and a highly visible LED status indicator. Each device is equipped with a sensitivity adjuster and a light-on/dark-on changeover switch for increased flexibility. A wide variety of versions are available in both infrared light and red light with PowerBeam for easy alignment. Special versions with BlueBeam are suitable for challenging applications like those in the solar and battery industries.

Dimensions

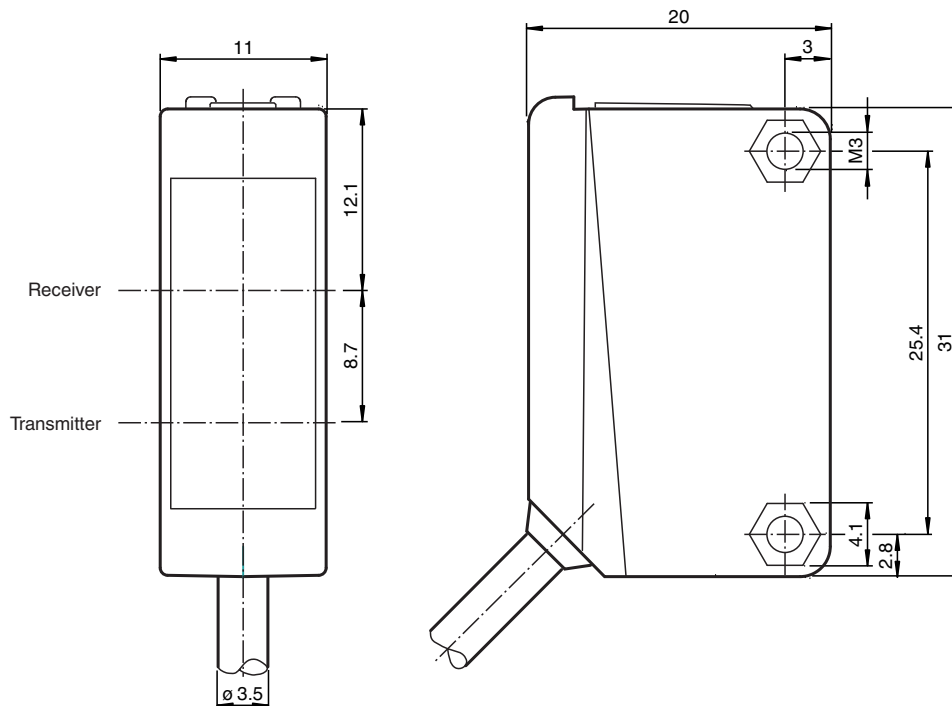

Release date: 2023-04-05 Date of issue: 2023-04-05 Filename: 820041_eng.pdf

Refer to "General Notes Relating to Pepperl+Fuchs Product Information".

Pepperl+Fuchs Group
www.pepperl-fuchs.com

USA: +1 330 486 0001
fa-info@us.pepperl-fuchs.com

Germany: +49 621 776 1111
fa-info@de.pepperl-fuchs.com

Singapore: +65 6779 9091
fa-info@sg.pepperl-fuchs.com

pff PEPPERL+FUCHS

Technical Data

General specifications		
Detection range		7 ... 100 mm
Adjustment range		30 ... 100 mm
Reference target		standard white, 100 mm x 100 mm
Light source		IRED
Light type		modulated infrared light
Polarization filter		no
Diameter of the light spot		approx. 7 mm x 50 mm at 100 mm
Opening angle		Emitter: 3.5 ° vertical ; 30 ° horizontal
Optical face		frontal
Ambient light limit		EN 60947-5-2:2007+A1:2012
Functional safety related parameters		
MTTF _d		860 a
Mission Time (T _M)		20 a
Diagnostic Coverage (DC)		0 %
Indicators/operating means		
Operation indicator		LED green: power on
Function indicator		LED yellow: lights when object is detected
Control elements		Sensing range adjuster
Control elements		Light-on/dark-on changeover switch
Electrical specifications		
Operating voltage	U _B	10 ... 30 V DC
Ripple		max. 10 %
No-load supply current	I ₀	< 20 mA
Output		
Switching type		The switching type of the sensor is adjustable. The default setting is: light-on
Signal output		1 PNP output, short-circuit protected, reverse polarity protected, open collector
Switching voltage		max. 30 V DC
Switching current		max. 100 mA , resistive load
Voltage drop	U _d	≤ 1.5 V DC
Switching frequency	f	500 Hz
Response time		1 ms
Conformity		
Product standard		EN 60947-5-2
Approvals and certificates		
UL approval		cULus Listed, Class 2 Power Source or listed Power Supply with a limited voltage output with (maybe integrated) fuse (max. 3.3 A according UL248), Type 1 enclosure
CCC approval		CCC approval / marking not required for products rated ≤36 V
Ambient conditions		
Ambient temperature		-30 ... 60 °C (-22 ... 140 °F)
Storage temperature		-40 ... 70 °C (-40 ... 158 °F)
Mechanical specifications		
Housing width		11 mm
Housing height		31 mm
Housing depth		20 mm
Degree of protection		IP67
Connection		2 m fixed cable
Material		
Housing		PC (Polycarbonate)
Optical face		PMMA
Mass		approx. 50 g
Tightening torque, fastening screws		0.6 Nm
Cable length		2 m

Release date: 2023-04-05 Date of issue: 2023-04-05 Filename: 820041_eng.pdf

Refer to "General Notes Relating to Pepperl+Fuchs Product Information".

Connection

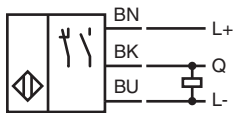

Assembly

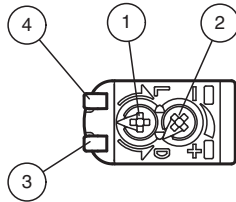

1	Light-Dark-switching	
2	Sensitivity adjuster	
3	Signal display	yellow
4	Operating display	green



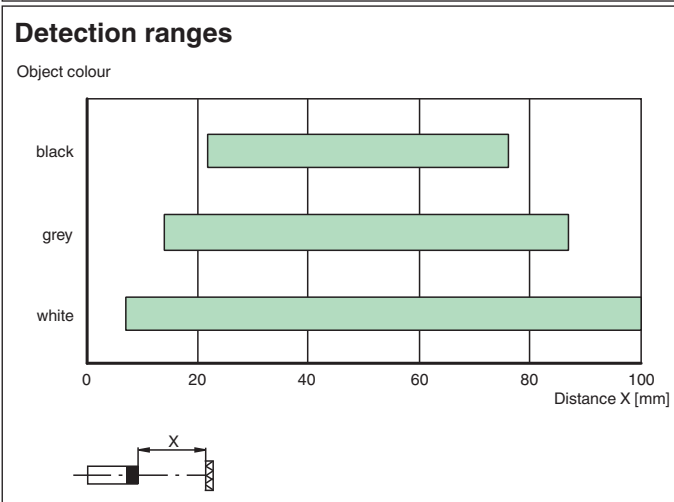
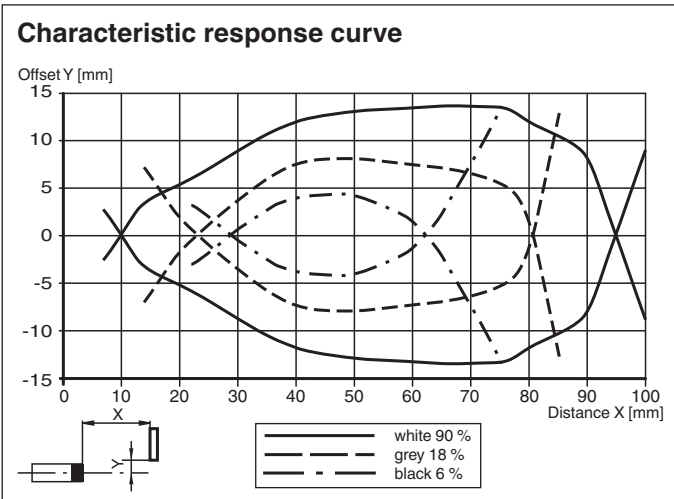





Characteristic Curve



Release date: 2023-04-05 Date of issue: 2023-04-05 Filename: 820041_eng.pdf

Refer to "General Notes Relating to Pepperl+Fuchs Product Information".

Accessories

	OMH-ML100-09	Mounting aid for round steel ø 12 mm or sheet 1.5 mm ... 3 mm
	OMH-ML100-01	Mounting aid for ML100 series, mounting bracket
	OMH-ML100-02	Mounting aid for ML100 series, mounting bracket
	OMH-ML100-03	Mounting aid for round steel ø 12 mm or sheet 1.5 mm ... 3 mm
	OMH-ML100-04	Mounting aid for ML100 series, mounting bracket
	OMH-ML100-05	Mounting aid for ML100 series, mounting bracket
	OMH-F10-ML100	Mounting aid for ML100 series
	OMH-10	Mounting aid for ML100 series
	OMH-ML100-S1	Mounting bracket

Release date: 2023-04-05 Date of issue: 2023-04-05 Filename: 820041_eng.pdf

Refer to "General Notes Relating to Pepperl+Fuchs Product Information".

Pepperl+Fuchs Group
www.pepperl-fuchs.com

USA: +1 330 486 0001
fa-info@us.pepperl-fuchs.com

Germany: +49 621 776 1111
fa-info@de.pepperl-fuchs.com

Singapore: +65 6779 9091
fa-info@sg.pepperl-fuchs.com