



Model Number

RLK61-8-H-500-IR-Z/31/115

Background suppression sensor with fixed cable

Features

- Cost-optimized series for standard tasks in a special design
- Compact design
- Wide range of mounting options thanks to cubic housing design with M30 thread
- 360° high visibility LEDs
- Programmable ON-delay, OFF-delay, and One-shot timers
- Version for universal voltages
- Relay output

Product information

The Series 61 sensor family is a comprehensive product line, offering five sensing modes. Each sensor is equipped with four LEDs that are highly visible from all directions, indicating Power-On, target presence and marginal excess gain. The widely recognized, polycarbonate housing provides a IP67 protection degree rating. Color-coded labels are clearly printed on the housing to easily identify the sensing mode. DC models offer a 4-in-1 output while AC/DC models have a SPDT relay output rated to 3 A. All versions come standard with an integral multifunction timer, sensitivity adjustment and Light-ON/Dark-ON switch. Series 61 sensors are cross-talk protected and have a high degree of resistance to ambient lighting. Each sensor can be mounted via front and rear slots, rear dovetail guide or M30 x 1.5 mounting base. Additionally, cabled sensor models provide 1/2" - 14 NPT internal threads for use with flexible conduit.

Dimensions

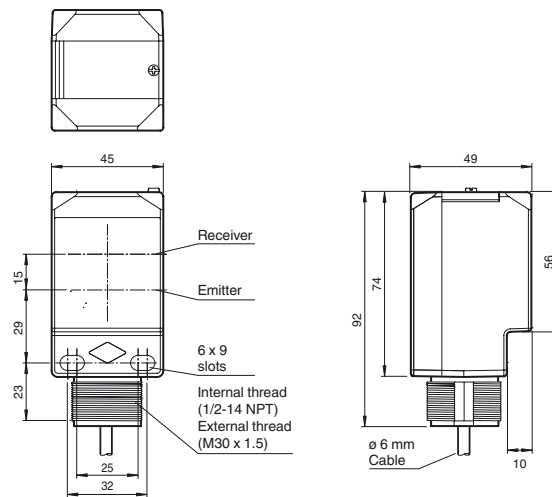

Electrical connection

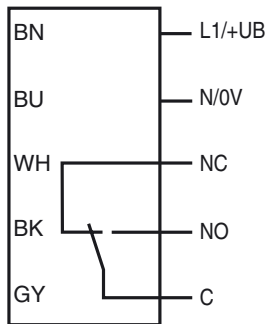

Indicators/operating means

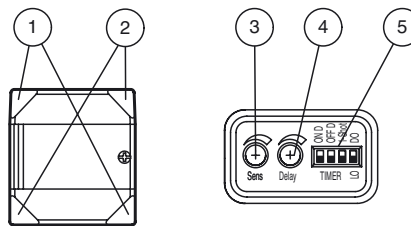

1	Operating display	green
2	Signal display	yellow
3	Sensing range adjuster	
4	Time adjuster	
5	DIP-switches	

Release date: 2017-03-21 14:13 Date of issue: 2017-03-21 911631_eng.xml

Refer to "General Notes Relating to Pepperl+Fuchs Product Information".

Technical data**General specifications**

Detection range	20 ... 500 mm
Detection range min.	20 ... 200 mm
Detection range max.	20 ... 500 mm
Adjustment range	200 ... 500 mm
Background suppression	max. + 10 % of the upper limit of the detection range
Light source	IREL
Light type	modulated infrared light , 850 nm
Black/White difference (6%/90%)	< 8 % at 500 mm sensor range
Diameter of the light spot	approx. 6 mm at a distance of 500 mm
Angle of divergence	0.7 °
Optical face	frontal
Ambient light limit	5000 Lux ; according EN 60947-5-2

Indicators/operating means

Operation indicator	2 LEDs green
Function indicator	2 LEDs yellow ON: object inside the scanning range OFF: object outside the scanning range
Control elements	Light-on/dark-on changeover switch
Control elements	Sensing range adjuster
Control elements	Time adjuster (0 ... 10 s)

Electrical specifications

Operating voltage	U_B	24 ... 240 V AC 12 ... 240 V DC
No-load supply current	I_0	≤ 35 mA
Protection class		II , rated voltage ≤ 250 V AC with pollution degree 1-2 according to IEC 60664-1 Output circuit basis insulation of input circuit according to EN 50178, rated insulation voltage 240 V AC
Power consumption	P_0	≤ 2 VA

Output

Switching type	light/dark on, switchable	
Signal output	1 SPDT relay	
Switching voltage	max. 250 V AC/DC	
Switching current	max. 3 A	
Switching power	DC: max. 150 W AC: max. 750 VA	
Switching frequency	f	20 Hz
Response time		≤ 25 ms
Timer function		DIP-switch for selection of operating modes

Ambient conditions

Ambient temperature	-40 ... 55 °C (-40 ... 131 °F)
Storage temperature	-40 ... 70 °C (-40 ... 158 °F)

Mechanical specifications

Degree of protection	IP67
Connection	2 m fixed cable , 5-wire
Material	
Housing	PC (Polycarbonate)
Optical face	PMMA
Mass	approx. 240 g
Tightening torque, fastening screws	≤ 2 Nm
Cable length	2 m

Compliance with standards and directives

Directive conformity	
EMC Directive 2004/108/EC	EN 60947-5-2:2007+A1:2012
Standard conformity	
Product standard	EN 60947-5-2:2007 IEC 60947-5-2:2007
Standards	EN 50178, UL 508

Approvals and certificates

EAC conformity	TR CU 020/2011 TR CU 004/2011
UL approval	cULus Listed, Type 1 enclosure For overcurrent protection, install a fuse with a rated current of max. 5 A and min. 240 V AC/DC
CCC approval	Certified by China Compulsory Certification (CCC)

Accessories**MPZB01**

Mounting bracket with vertical slots

MPZB02

Mounting bracket with circular slots

MPZB06

Ball and Swivel Mounting Bracket

MPZB07

Ball and Swivel Vertical Mounting Plate

Other suitable accessories can be found at www.pepperl-fuchs.com

Curves/Diagrams

Movement Characteristic

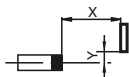
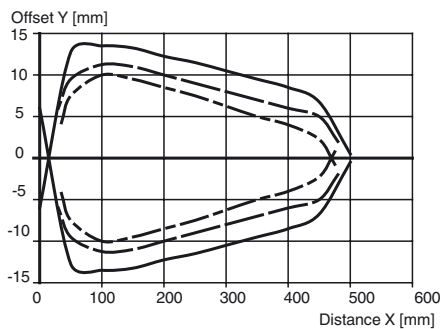

—	white 90 %
- - -	grey 18 %
- · - · -	black 6 %

Difference in detection distance

RL(K)61-8-H-500-RT

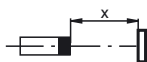
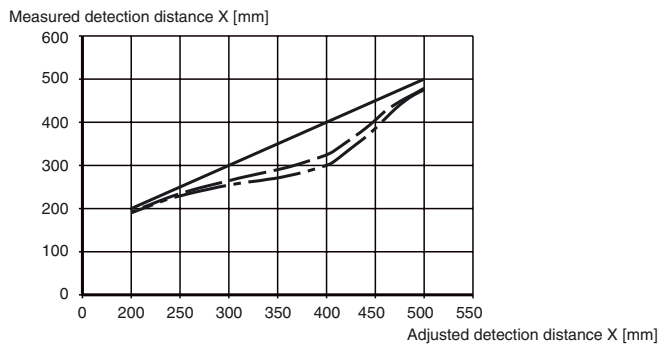

—	white 90 %
- - -	grey 18 %
- · - · -	black 6 %

Release date: 2017-03-21 14:13 Date of issue: 2017-03-21 911631_eng.xml

Refer to "General Notes Relating to Pepperl+Fuchs Product Information".

Pepperl+Fuchs Group
www.pepperl-fuchs.com

USA: +1 330 486 0001
fa-info@us.pepperl-fuchs.com

Germany: +49 621 776 4411
fa-info@de.pepperl-fuchs.com

Singapore: +65 6779 9091
fa-info@sg.pepperl-fuchs.com

Timer Functions

Switching Type	Detection Status	Operation Mode	Light Received	No Light Received
L.ON				
OFF ON ON D OFF D OFF D i-Shot DO Timer LO	No Delay (Timer OFF)		ON	OFF
OFF ON ON D OFF D OFF D i-Shot DO Timer LO	ON Delay		ON	OFF
OFF ON ON D OFF D OFF D i-Shot DO Timer LO	OFF Delay		ON	OFF
OFF ON ON D OFF D OFF D i-Shot DO Timer LO	One-Shot Delay		ON	OFF
OFF ON ON D OFF D OFF D i-Shot DO Timer LO	ON Delay and OFF Delay		ON	OFF
D.ON				
OFF ON ON D OFF D OFF D i-Shot DO Timer LO	No Delay (Timer OFF)		ON	OFF
OFF ON ON D OFF D OFF D i-Shot DO Timer LO	ON Delay		ON	OFF
OFF ON ON D OFF D OFF D i-Shot DO Timer LO	OFF Delay		ON	OFF
OFF ON ON D OFF D OFF D i-Shot DO Timer LO	One-Shot Delay		ON	OFF
OFF ON ON D OFF D OFF D i-Shot DO Timer LO	ON Delay and OFF Delay		ON	OFF

DIP-Switch position 

Time (T) is adjustable from 0 to 10 s

Release date: 2017-03-21 14:13 Date of issue: 2017-03-21 911631_eng.xml

Adjustment Instructions

Intended use:

The transmitter and receiver are located in the same housing of Diffuse Mode sensors with Background Suppression. The suppression of objects outside the sensing range is achieved by arranging the angle between the transmitter and receiver (2 receiver elements).

Objects are detected independently of their surface structures, brightness and color, as well as the brightness of the background.

Mounting instructions:

The sensors can be fastened directly with fixing screws or with a mounting bracket (not included with delivery).

The surface underneath must be flat to prevent the housing from moving when the sensor is tightened into position. We recommend securing the nut and screw in place with lock washers to prevent the sensor from going out of adjustment.

Adjustment:

After the operating voltage is applied, the green LEDs light up.

Align the sensor to the background. If the yellow LEDs are lit, the sensing range should be reduced with the sensing range adjuster until the yellow LEDs turn off.

Object detection:

Place the object to be detected at the desired maximum sensing range and align the light spot to it. If the object is detected, the yellow LED lights up.

If they do not light up, the sensing range must be adjusted on the potentiometer until the yellow LEDs light up indicating that an object is detected.

Cleaning:

We recommend cleaning the optical surface and checking all of the connections at regular intervals.