

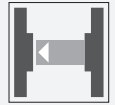

## Thru-beam sensor M41/MV41/25/76a/92/136



- Rugged series in corrosion-resistant metal housing
- Long sensor range with high power mode
- Resistant against noise: reliable operation under all conditions
- Clear and functional display concept for the operating modes
- Aluminum housing with high quality Delta-Seal coated
- Scratch-resistant and solvent resistant glass lens

Robust thru-beam sensor, compact housing design, 16 m detection range, emission frequency F1, red light and infrared light, light on, 2 push-pull outputs, test input, M12 plug



### Function

The unique and extremely popular design of the MLV41 series enables it be mounted correctly in confined areas and offers all the functions that are normally only found on larger phototelectric sensors. The MLV41 series comes with a range of functions. For example, highly visible status LEDs on the front and back, resistance to ambient light, crosstalk protection and universally applicable output stages that permit every possible switching logic and polarity to be realized. The enhanced resistance to ambient light ensures reliable operation even where modern energy-saving lamps with electronic ballasts are in use. The same applies where multiple devices are present, i.e. the use of a number of sensors in the same vicinity causes no problems.

## Dimensions

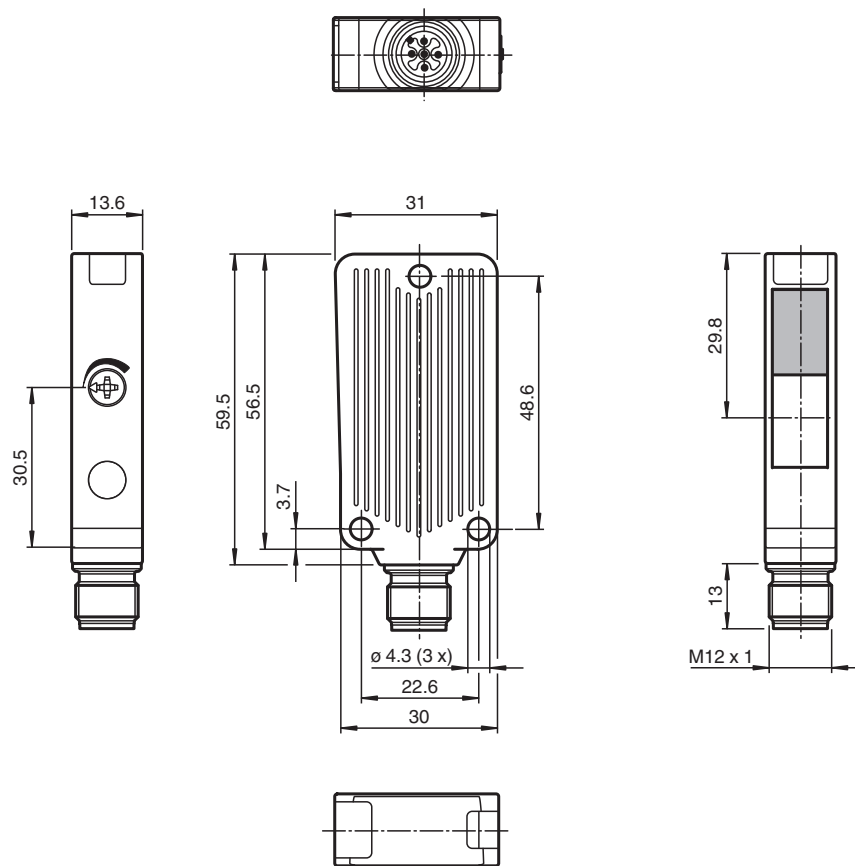

## Technical Data

### System components

Emitter	M41/76a/92
Receiver	MV41/25/92/136

### General specifications

Effective detection range	0 ... 16 m
Threshold detection range	normal mode: 25 m High power mode: 35 m (Control input at UB+)
Light source	normal mode: LED High power mode: LED+IRED
Light type	normal mode: modulated visible red light High power mode: Red and infrared, modulated light
Diameter of the light spot	approx. 500 mm at detection range 16 m
Angle of divergence	approx. 1.5 °
Optical face	frontal
Ambient light limit	50000 Lux

### Functional safety related parameters

MTTF <sub>d</sub>	844 a
Mission Time (T <sub>M</sub> )	20 a
Diagnostic Coverage (DC)	0 %

### Indicators/operating means

Operation indicator	LED green: power on
Function indicator	Receiver: LED yellow, lights up when light beam is free, flashes when falling short of the stability control ; OFF when light beam is interrupted
Control elements	sensitivity adjustment (receiver)

### Electrical specifications

Release date: 2021-09-29 Date of issue: 2021-09-29 Filename: t161282\_eng.pdf

## Technical Data

Operating voltage	$U_B$	10 ... 30 V DC , class 2
Ripple		max. 10 %
No-load supply current	$I_0$	max. 30 mA
<b>Input</b>		
Test input		emitter deactivation at + $U_B$ (emitter)
Control input		High power mode activation with +UB (emitter)
<b>Output</b>		
Switching type		light-on
Signal output		2 push-pull (4 in 1) outputs, complementary, short-circuit proof, reverse polarity protected
Switching voltage		max. 30 V DC
Switching current		max. 100 mA
Voltage drop	$U_d$	$\leq 2.5$ V DC
Switching frequency	$f$	1000 Hz
Response time		0.5 ms
<b>Compliance with standards and directives</b>		
Directive conformity		
EMC Directive 2004/108/EC		EN 60947-5-2:2007
Standard conformity		
Product standard		EN 60947-5-2:2007 IEC 60947-5-2:2007
Standards		UL 508
<b>Approvals and certificates</b>		
UL approval		cULus Listed, Class 2 Power Source, Type 1 enclosure
CCC approval		CCC approval / marking not required for products rated $\leq 36$ V
<b>Ambient conditions</b>		
Ambient temperature		-40 ... 60 °C (-40 ... 140 °F)
Storage temperature		-40 ... 75 °C (-40 ... 167 °F)
<b>Mechanical specifications</b>		
Housing width		31 mm
Housing height		56.5 mm
Housing depth		13.6 mm
Degree of protection		IP67
Connection		4-pin, M12 x 1 connector
Material		
Housing		Aluminum , Delta-Seal coated
Optical face		glass pane
Connector		metal
Mass		50 g (device)

Release date: 2021-09-29 Date of issue: 2021-09-29 Filename: t161282\_eng.pdf

Refer to "General Notes Relating to Pepperl+Fuchs Product Information".

Pepperl+Fuchs Group  
www.pepperl-fuchs.com

USA: +1 330 486 0001  
fa-info@us.pepperl-fuchs.com

Germany: +49 621 776 1111  
fa-info@de.pepperl-fuchs.com

Singapore: +65 6779 9091  
fa-info@sg.pepperl-fuchs.com

 PEPPERL+FUCHS

**Connection Assignment**

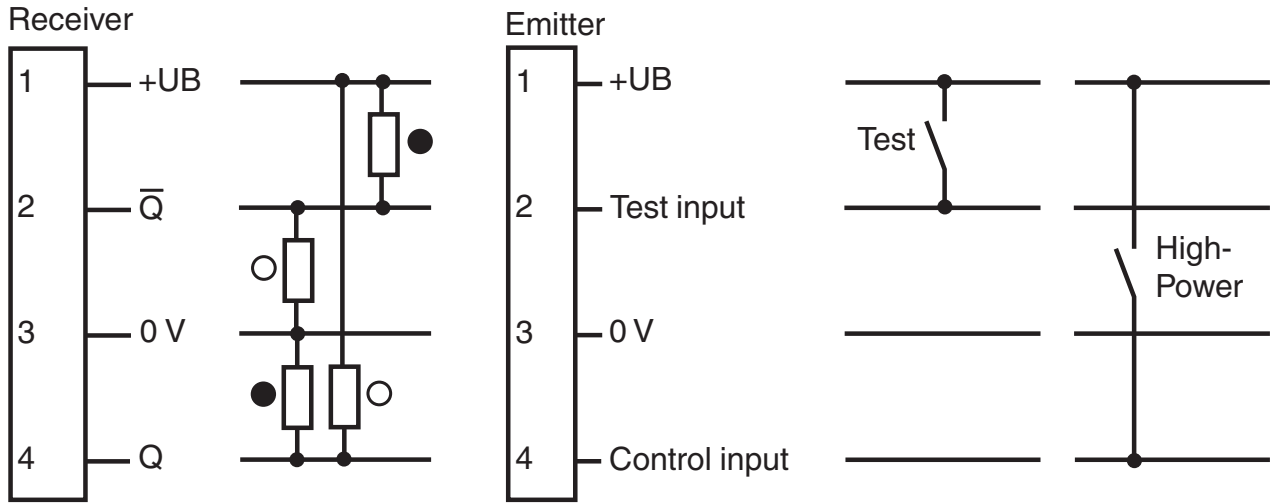

○ = Light on  
● = Dark on

**Connection Assignment**

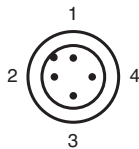

Wire colors in accordance with EN 60947-5-2

- 1 | BN (brown)
- 2 | WH (white)
- 3 | BU (blue)
- 4 | BK (black)

**Assembly**

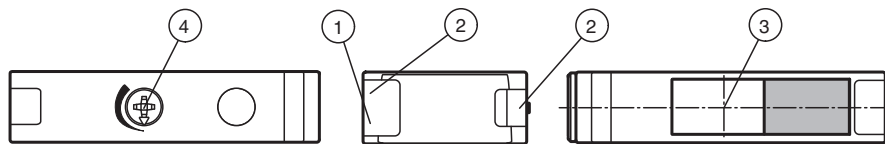

1 Operating display green	2 Function display yellow	3 Optical axis
4 Sensitivity adjustment (only receiver)		

Release date: 2021-09-29 Date of issue: 2021-09-29 Filename: t161282\_eng.pdf

Refer to "General Notes Relating to Pepperl+Fuchs Product Information".

Pepperl+Fuchs Group  
www.pepperl-fuchs.com

USA: +1 330 486 0001  
fa-info@us.pepperl-fuchs.com



Germany: +49 621 776 1111  
fa-info@de.pepperl-fuchs.com

Singapore: +65 6779 9091  
fa-info@sg.pepperl-fuchs.com

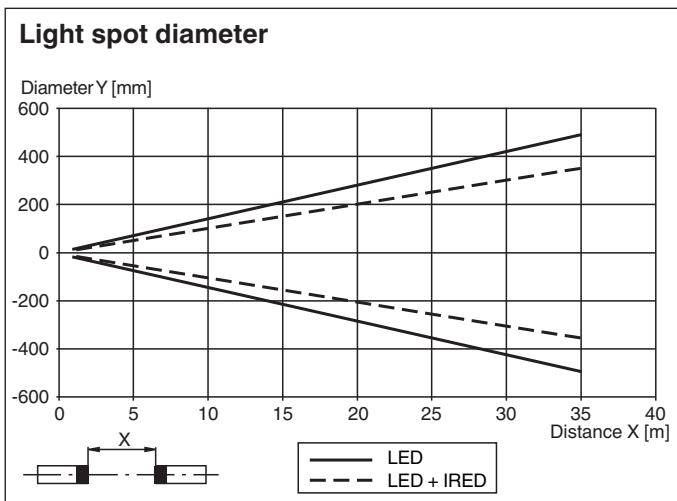
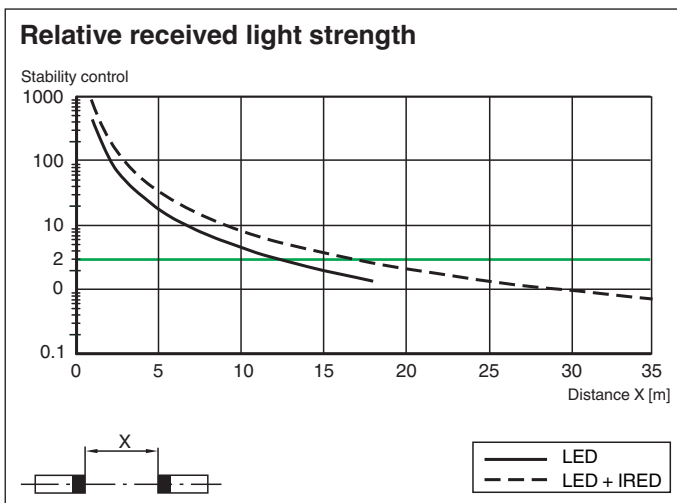
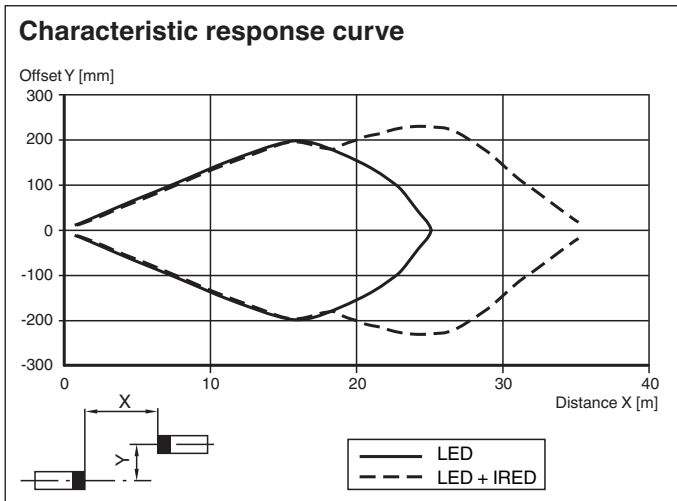
## Characteristic Curve



## Accessories

	<b>OMH-09</b>	Mounting bracket for Sensors series MLV41 for M12 rod mounting
	<b>OMH-40</b>	Mounting bracket
	<b>V31-WM-2M-PUR</b>	Female cordset single-ended M8 angled A-coded, 4-pin, PUR cable grey

Release date: 2021-09-29 Date of issue: 2021-09-29 Filename: t161282\_eng.pdf

Refer to "General Notes Relating to Pepperl+Fuchs Product Information".

Pepperl+Fuchs Group  
www.pepperl-fuchs.com

USA: +1 330 486 0001  
fa-info@us.pepperl-fuchs.com

Germany: +49 621 776 1111  
fa-info@de.pepperl-fuchs.com

Singapore: +65 6779 9091  
fa-info@sg.pepperl-fuchs.com

 **PEPPERL+FUCHS**

## Accessories



**V31-GM-2M-PUR**

Female cordset single-ended M8 straight A-coded, 4-pin, PUR cable grey

Release date: 2021-09-29 Date of issue: 2021-09-29 Filename: t161282\_eng.pdf

Refer to "General Notes Relating to Pepperl+Fuchs Product Information".

Pepperl+Fuchs Group  
www.pepperl-fuchs.com

USA: +1 330 486 0001  
fa-info@us.pepperl-fuchs.com

Germany: +49 621 776 1111  
fa-info@de.pepperl-fuchs.com

Singapore: +65 6779 9091  
fa-info@sg.pepperl-fuchs.com

 **PEPPERL+FUCHS**