



Absolute rotary encoder

ENA58IL-R***-SSI

- Recessed hollow shaft
- SSI interface
- Up to 32 Bit multiturn
- Free of wear magnetic sampling
- High resolution and accuracy
- Additionally push buttons for preset function (only model characteristic SB2, SG2)
- Up to 4096 pulses on incremental track



Function

The ENA58IL series are high precision encoders with internal magnetic sampling. This multiturn absolute encoder transmits a position value corresponding to the shaft setting via the SSI interface (Synchronous Serial Interface). The control module sends a start sequence to the absolute encoder to obtain the position data. The rotary encoder then sends the position data synchronous to the cycles of the control module. It is possible to select the counting direction with the function input.

Dimensions

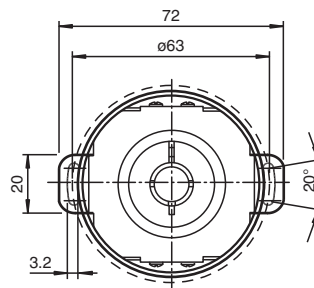
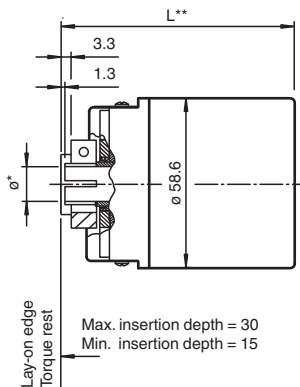

* See type code

** Singleturn design with axial output: L = 60.6
All other designs: L = 71 mm

Recessed hollow shaft

Dimensions

Connections

Dimensions in mm

Cable

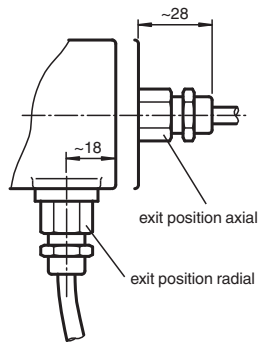

Connector M12

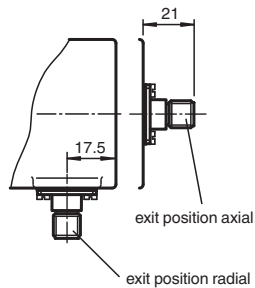

Connector M23

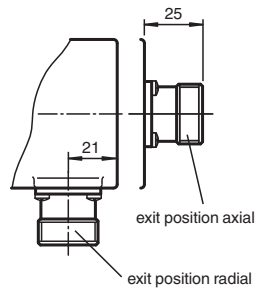

Technical Data

General specifications	
Detection type	magnetic sampling
Device type	Absolute rotary encoder
Linearity error	$\pm 0.1^\circ$
UL File Number	E223176 "For use in NFPA 79 Applications only", if UL marking is marked on the product.
Functional safety related parameters	
MTTF _d	700 a at 40 °C
Mission Time (T _M)	20 a
L ₁₀	5 E+8 revolutions at 24/198 N axial/radial shaft load
Diagnostic Coverage (DC)	0 %
Electrical specifications	
Operating voltage	U _B 4.5 ... 30 V DC (SSI, SSI + RS422) ; 10 ... 30 V DC (SSI + Push/Pull)
No-load supply current	I ₀ typ. 50 mA
Power consumption	P ₀ approx. 1.5 W
Time delay before availability	t _v < 450 ms
Output code	Gray code, binary code
Code course (counting direction)	adjustable
Interface	
Interface type	SSI ; SSI + incremental track
Resolution	
Single turn	up to 16 Bit
Multiturn	up to 16 Bit
Overall resolution	up to 32 Bit
Transfer rate	0.1 ... 2 MBit/s
Cycle time	< 100 μs
Standard conformity	RS 422
Input 1	
Input type	Selection of counting direction (cw/ccw)
Signal voltage	
High	4.75 V ... U _B or unconnected (cw descending)
Low	0 ... 2 V (cw ascending)
Input current	< 6 mA
Switch-on delay	< 250 ms



Release date: 2023-07-31 Date of issue: 2023-07-31 Filename: t168601_eng.pdf

Refer to "General Notes Relating to Pepperl+Fuchs Product Information".

Technical Data

Input 2	
Input type	zero-set (PRESET 1) with falling edge
Signal voltage	
High	4.75 V ... U_B
Low	0 ... 2 V
Input current	< 6 mA
Signal duration	min. 1.1 s
Output	
Output type	RS422, Push/Pull
Signal output	A+B+/A+/B
Pulses	1024, 2048, 4096
Connection	
Connector	M12 connector, 8-pin or M23 connector, 12-pin
Cable	∅7 mm, 6 x 2 x 0.14 mm ²
Standard conformity	
Degree of protection	DIN EN 60529, IP65 or IP67 (not for M23 device plug)
Climatic testing	DIN EN 60068-2-3, no moisture condensation
Emitted interference	EN 61000-6-4:2007
Noise immunity	EN 61000-6-2:2005
Shock resistance	DIN EN 60068-2-27, 200 g, 6 ms
Vibration resistance	DIN EN 60068-2-6, 20 g, 10 ... 1000 Hz
Approvals and certificates	
UL approval	cULus Listed, General Purpose, Class 2 Power Source, if UL marking is marked on the product.
Ambient conditions	
Operating temperature	cable, flexing: -5 ... 70 °C (23 ... 158 °F), cable, fixed: -30 ... 70 °C (-22 ... 158 °F) connector models: -40 ... 85 °C (-40 ... 185 °F)
Storage temperature	-40 ... 85 °C (-40 ... 185 °F)
Relative humidity	98 % , no moisture condensation
Mechanical specifications	
Material	
Housing	nickel-plated steel , painted
Flange	Aluminum
Shaft	Stainless steel
Mass	approx. 300 g , with cable
Rotational speed	max. 12000 min ⁻¹
Moment of inertia	50 gcm ²
Starting torque	< 5 Ncm
Shaft load	
Axial	24 N
Radial	198 N
Angle offset	± 0.9 °
Axial offset	± 0.3 mm static
Radial offset	± 0.5 mm static











Accessories

	V19-G-2M-PUR-ABG-V19-G	Cordset M12 socket straight to M12 plug straight A-coded, 8-pin, PUR cable grey, shielded
	V19-G-2M-PUR-ABG	Female cordset single-ended M12 straight A-coded, 8-pin, PUR cable grey, shielded

Release date: 2023-07-31 Date of issue: 2023-07-31 Filename: t168601_eng.pdf

Refer to "General Notes Relating to Pepperl+Fuchs Product Information".

Accessories

	V19-G-5M-PUR-ABG	Female cordset single-ended M12 straight A-coded, 8-pin, PUR cable grey, shielded
	V19-W-ABG-PG9	Female connector M12 angled A-coded 8-pin, for cable diameter 5 - 8 mm, shielded, field-attachable
	V19-G-ABG-PG9	Female connector M12 straight A-coded 8-pin, for cable diameter 5 - 8 mm, shielded, field-attachable
	V19-G-2M-PVC-TP	Female cordset, M12, 8-pin, shielded, PVC cable
	V19-G-5M-PVC-TP	Female cordset, M12, 8-pin, shielded, PVC cable
	V19-G-10M-PVC-TP	Female cordset, M12, 8-pin, shielded, PVC cable
	ACC-PACK-ABS-_S_58 ø15	Accessory kit for Ø58 absolute rotary encoder with recessed hollow shaft 15 mm
	ACC-PACK-ABS-_S_58 ø14	Accessories set for Ø58 absolute rotary encoder with recessed hollow shaft 14 mm
	ACC-PACK-ABS-_S_58 ø12	Accessories set for Ø58 absolute rotary encoder with recessed hollow shaft 12 mm
	ACC-PACK-ABS-_S_58 ø10	Accessory kit for Ø58 absolute rotary encoder with recessed hollow shaft 10 mm

Connection

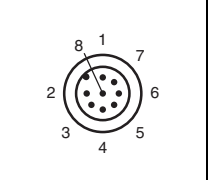
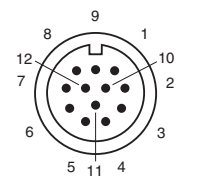
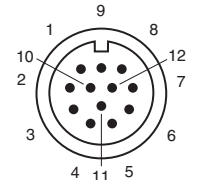
Signal	Cable, 12-core	Connector M12, 8-pin	Connector M23, 12-pin, cw	Connector M23, 12-pin, ccw	Explanation
GND (encoder)	White	1	1	1	Power supply
U_B (encoder)	Brown	2	2	8	Power supply
Clock (+)	Green	3	3	3	Positive cycle line
Clock (-)	Yellow	4	4	11	Negative cycle line
Data (+)	Grey	5	5	2	Positive transmission data
Data (-)	Pink	6	6	10	Negative transmission data
A	Black		7	12	Incremental track A
V/R	Red	8	8	5	Input for selection of counting direction
PRESET 1	Blue	7	9	9	Zero-setting input
B	Grey/Pink		10	4	Incremental track B
\bar{A}	Violet		11	6	Incremental track \bar{A}
\bar{B}	Red/Blue		12	7	Incremental track \bar{B}
					

Operation

Signal output

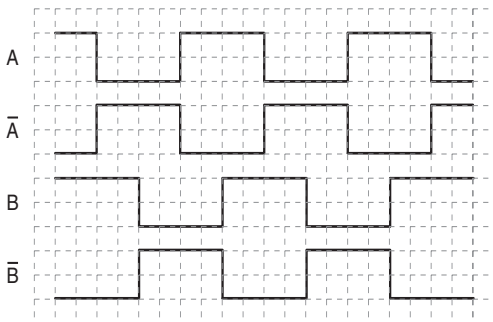

cw - with view onto the shaft

Interface

The Synchronous Serial Interface was specially developed for transferring the output data of an absolute encoder to a control device. The control module sends a clock bundle and the absolute encoder responds with the position value. Thus only 4 lines are required for the clock and data, no matter what the resolution of the rotary encoder is. The RS 422 interface is optically isolated from the power supply.

SSI signal course Standard

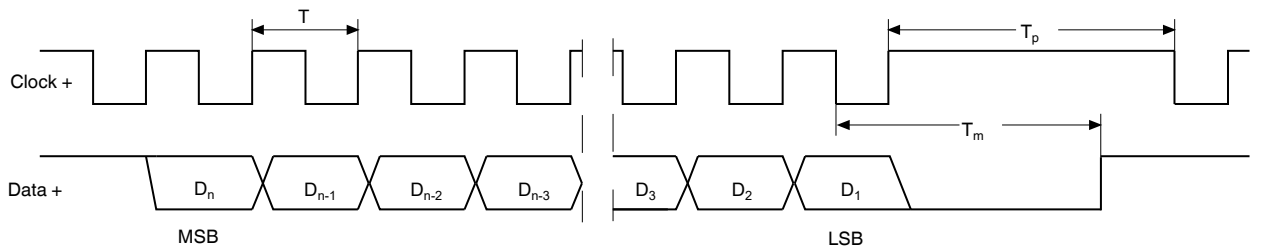

D_1, \dots, D_n : Position data
 MSB: Most significant bit
 LSB: Least significant bit
 $T = 1/f$: Duration of period of clock signal ≤ 2 MHz
 T_m : Monoflop time $20 \mu s \pm 1 \mu s$
 T_p : Clock pause \geq monoflop time ($T_p \geq T_m$)

Release date: 2023-07-31 Date of issue: 2023-07-31 Filename: t168601_eng.pdf

SSI output format Standard

- At idle status signal lines "Data +" and "Clock +" are at high level (5 V).
- The first time the clock signal switches from high to low, the data transfer in which the current information (position data (D_n)) is stored in the encoder is introduced.
- The highest order bit (MSB) is applied to the serial data output of the encoder with the first rising pulse edge.
- The next successive lower order bit is transferred with each following rising pulse edge.
- After the lowest order bit (LSB) has been transferred the data line switches to low until the monoflop time T_m has expired.
- No subsequent data transfer can be started until the data line switches to high again or the time for the clock pause T_p has expired.
- After the clock sequence is complete, the monoflop time T_m is triggered with the last falling pulse edge.
- The monoflop time T_m determines the lowest transmission frequency.

SSI output format ring slide operation (multiple transmission)

- In ring slide operation, multiple transmission of the same data word over the SSI interface makes it possible to offer the possibility of detecting transmission errors.
- In multiple transmission, n bits are transferred per data word in standard format. The value n equals the total resolution of the encoder.
As an example: a multiturn encoder with a resolution of 8192 steps/revolution (13 bit) and a max. number of 4096 revolutions (12 bit) has a total resolution of n = 25 bit.
- If the clock change is not interrupted after the last falling pulse edge, ring slide operation automatically becomes active. This means that the information that was stored at the time of the first clock change is generated again.
- After the first position transmission, the n+1 pulse controls data repetition. If the n+1 pulse follows after an amount of time greater than the monoflop time T_m, a new current data word will be transmitted with the following pulses.



If the pulse line is exchanged, the data word is generated offset.

Block diagram

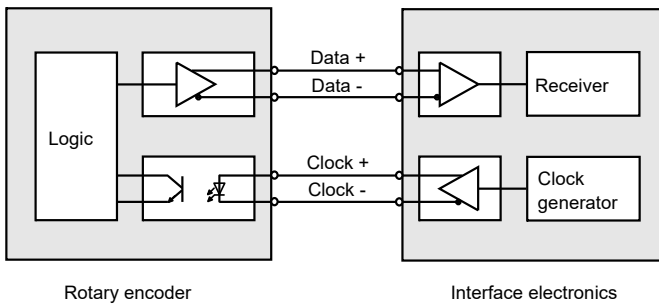

Line length

Line length in m	Baudrate in kHz
< 50	< 400
< 100	< 300
< 200	< 200
< 400	< 100

Parameterization

Push buttons on encoder with model characteristic SB2, SG2

In addition to the electrical preset function (PRESET 1) these models are equipped with 2 push buttons for manually setting the zero point of the rotary encoder.

Manually zero set

1. Simultaneously press and hold the push buttons A and B for 2 s.

After releasing the push buttons the rotary encoder sets the current position as zero point.

Type Code

Release date: 2023-07-31 Date of issue: 2023-07-31 Filename: t168601_eng.pdf



- Connection type**
C1 Cable, 1 m
C2 Cable, 2 m
C5 Cable, 5 m
CA Cable, 10 m
AA M23 device plug, cw
AB M23 device plug, ccw
BE M12 device plug, 8-pin (not available with SSI + incremental track)

- Connection alignment**
A axial
R radial

Electrical interface
SG1 ... SIC see next page

- Singleturn resolution**
12 12 bit
13 13 bit
16 16 bit

- Multiturn resolution**
00 Singleturn rotary encoder
12 Multiturn rotary encoder, 12 bit
14 Multiturn rotary encoder, 14 bit
16 Multiturn rotary encoder, 16 bit

- Degree of protection**
5 IP65
7 IP67 (not for M23 device plug)

- Flange**
DA Dual spring plate

- Shaft diameter**
06 6 mm (d = 6F7)
10 10 mm (d = 10 F7)
12 12 mm (d = 12 F7)
14 14 mm (d = 14 F7)
15 15 mm (d = 15 F7)

- Shaft type**
R Recessed hollow shaft

- Version**
IL Industrial Line

- Size**
58 Housing diameter: 58 mm

- Device type**
ENA Absolute rotary encoder



- Electrical interface**
SG1 SSI Gray
SB1 SSI binary
SG2 SSI Gray, with push buttons
SB2 SSI binary, with push buttons
SI1 SSI Gray + 1024 pulses, Push/Pull
SI2 SSI Gray + 2048 pulses, Push/Pull
SI3 SSI Gray + 4096 pulses, Push/Pull
SI4 SSI Gray + 1024 pulses, RS422
SI5 SSI Gray + 2048 pulses, RS422

Release date: 2023-07-31 Date of issue: 2023-07-31 Filename: t168601_eng.pdf

- SI6** SSI Gray + 4096 pulses, RS422
- SI7** SSI Binär + 1024 pulses, Push/Pull
- SI8** SSI Binär + 2048 pulses, Push/Pull
- SI9** SSI Binär + 4096 pulses, Push/Pull
- SIA** SSI Binär + 1024 pulses, RS422
- SIB** SSI Binär + 2048 pulses, RS422
- SIC** SSI Binär + 4096 pulses, RS422

Release date: 2023-07-31 Date of issue: 2023-07-31 Filename: t168601_eng.pdf

Refer to "General Notes Relating to Pepperl+Fuchs Product Information".

Pepperl+Fuchs Group
www.pepperl-fuchs.com

USA: +1 330 486 0001
fa-info@us.pepperl-fuchs.com

Germany: +49 621 776 1111
fa-info@de.pepperl-fuchs.com

Singapore: +65 6779 9091
fa-info@sg.pepperl-fuchs.com