



Absolute encoders ENA58IL-S***-CANopen

- Solid shaft
- Up to 31 bit overall resolution
- CANopen interface
- Free of wear magnetic sampling
- High resolution and accuracy



Function

This absolute rotary encoder provides a position value corresponding to the shaft position on its integrated CAN bus interface. The integrated CAN-bus interface supports all CANopen functions.

Thus the following modes can be programmed to either enabled or disabled:

- Polled mode
- Cyclic mode
- Sync mode

Dimensions

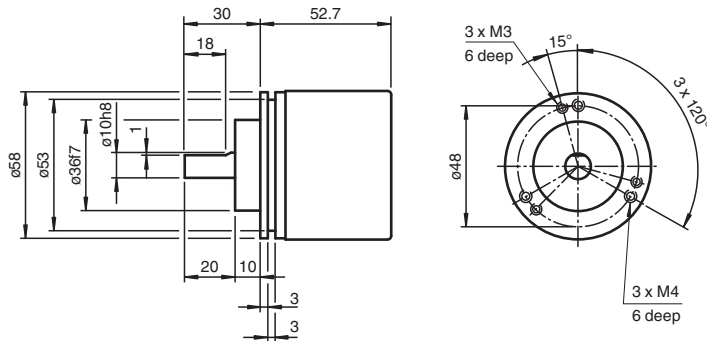

Clamping flange

Dimensions

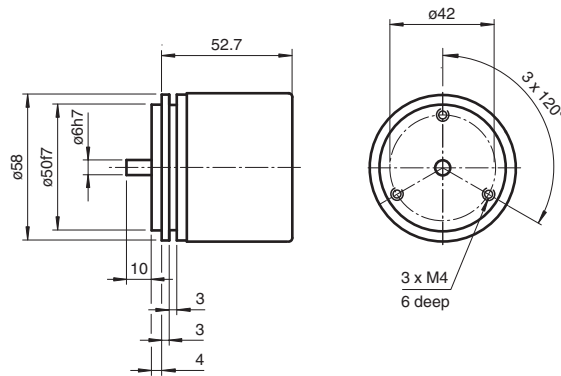

Servo flange

Connections

Dimensions in mm

Cable

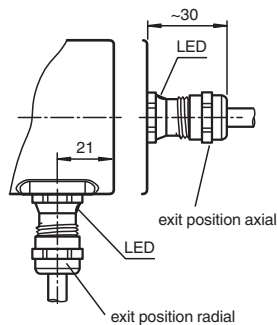

Connector M12

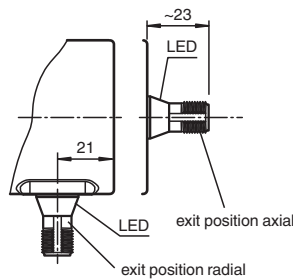

Technical Data





General specifications	
Detection type	magnetic sampling
Device type	Absolute encoders
Linearity error	$\pm 0.1^\circ$
UL File Number	E223176 "For use in NFPA 79 Applications only" , if UL marking is marked on the product.
Functional safety related parameters	
MTTF _d	480 a at 40 °C
Mission Time (T _M)	20 a
L ₁₀	55 E+8 revolutions at 40/110 N axial/radial shaft load
Diagnostic Coverage (DC)	0 %
Electrical specifications	
Operating voltage	U _B 9 ... 30 V DC (with galvanic isolation)
Power consumption	P ₀ ≤ 1.2 W
Time delay before availability	t _v < 250 ms
Output code	binary code
Code course (counting direction)	adjustable
Interface	
Interface type	CANopen
Resolution	

Release date: 2022-12-12 Date of issue: 2022-12-12 Filename: t183816_eng.pdf

Technical Data

Single turn	up to 16 Bit
Multiturn	up to 15 Bit
Overall resolution	up to 31 Bit
Transfer rate	min. 20 kBit/s , max. 1 MBit/s
Cycle time	≥ 1 ms
Standard conformity	DSP 406
Connection	
Connector	M12 connector, 5 pin
Cable	Ø6 mm, 4 x 2 x 0.14 mm ²
Standard conformity	
Degree of protection	DIN EN 60529, IP65 or IP67
Climatic testing	DIN EN 60068-2-3, no moisture condensation
Emitted interference	EN 61000-6-4:2007
Noise immunity	EN 61000-6-2:2005
Shock resistance	DIN EN 60068-2-27, 200 g, 6 ms
Vibration resistance	DIN EN 60068-2-6, 20 g, 10 ... 1000 Hz
Approvals and certificates	
UL approval	cULus Listed, General Purpose, Class 2 Power Source , if UL marking is marked on the product.
Ambient conditions	
Operating temperature	cable, flexing: -5 ... 70 °C (23 ... 158 °F), cable, fixed: -30 ... 70 °C (-22 ... 158 °F) connector models: -40 ... 85 °C (-40 ... 185 °F)
Storage temperature	-40 ... 85 °C (-40 ... 185 °F)
Relative humidity	98 % , no moisture condensation
Mechanical specifications	
Material	
Housing	nickel-plated steel , painted
Flange	Aluminum
Shaft	Stainless steel
Mass	approx. 300 g
Rotational speed	max. 12000 min ⁻¹
Moment of inertia	50 gcm ²
Starting torque	< 5 Ncm
Shaft load	
Axial	40 N
Radial	110 N

Accessories

	V15-G-BK2M-PUR-O2/CAN	DeviceNet/CANOpen bus cable female cordset single-ended M12 straight A-coded 5-pin, PUR cable 4-core twisted pairs black, shielded, UL approved, drag chain suitable, outdoor
	V15-G-BK5M-PUR-O2/CAN	DeviceNet/CANOpen bus cable female cordset single-ended M12 straight A-coded 5-pin, PUR cable 4-core twisted pairs black, shielded, UL approved, drag chain suitable, outdoor
	V15-G-BK10M-PUR-O2/CAN	DeviceNet/CANOpen bus cable female cordset single-ended M12 straight A-coded 5-pin, PUR cable 4-core twisted pairs black, shielded, UL approved, drag chain suitable, outdoor
	9108, 6	Measuring wheel
	9109, 6	Measuring wheel for shaft diameter 6 mm



Release date: 2022-12-12 Date of issue: 2022-12-12 Filename: t183816_eng.pdf

Refer to "General Notes Relating to Pepperl+Fuchs Product Information".

Pepperl+Fuchs Group
www.pepperl-fuchs.comUSA: +1 330 486 0001
fa-info@us.pepperl-fuchs.comGermany: +49 621 776 1111
fa-info@de.pepperl-fuchs.comSingapore: +65 6779 9091
fa-info@sg.pepperl-fuchs.com

PEPPERL+FUCHS

Accessories

	9110, 6	Measuring wheel for shaft diameter 6 mm
	9113, 6	Measuring wheel for shaft diameter 6 mm
	MBT-36ALS	Spring-loaded mounting bracket with a diameter of 36 mm

Release date: 2022-12-12 Date of issue: 2022-12-12 Filename: t183816_eng.pdf

Refer to "General Notes Relating to Pepperl+Fuchs Product Information".

Pepperl+Fuchs Group
www.pepperl-fuchs.com

USA: +1 330 486 0001
fa-info@us.pepperl-fuchs.com

Germany: +49 621 776 1111
fa-info@de.pepperl-fuchs.com

Singapore: +65 6779 9091
fa-info@sg.pepperl-fuchs.com

Connection

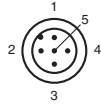
Signal	Wire end	5-pin, M12 x 1 connector
CAN GND	green	1
+V _S	red	2
GND	yellow	3
CAN-High	white	4
CAN-Low	brown	5
Shielding	Shielding	Housing
Pinout		

Indication

LED-indicator with dual color LED

CAN Run (green)	State	Description
Blinking	Pre-Operational	Boot up message is sent, device configuration is possible, device is in CAN state „Pre-Operational“
Single flash	Stopped	The Encoder is in CAN state „Stopped“
On	Operational	The encoder is in CAN state „Operational“
Off		No power supply

Err (red)	State	Description
Off	No error	The Encoder is in operating mode
Flickering	AutoBitrate	Auto baud mode is active and the encoder tries to find within the time out period a valid CAN message for baud rate measurement
Single flash	Warning limit reached	At least one of the error counters of the CAN controller has reached or exceeded the warning level (too many error frames)
Double flash	Error control event	A guard event (NTM slave or NTM master) or a heartbeat event has occurred
On	Bus off	The CAN controller is in stae bus off. No communication possible anymore. Too many error frames in the network.

Programming

Programmable CAN operating modes

Mode	Explanation
Polled mode	The connected host requests the current actual position value via a remote transmission request telegram. The absolute encoder reads in the current position, calculates all parameters that have been set and sends back the process actual value through the same CAN identifier.
Cyclic mode	The absolute encoder sends the current actual process value cyclically, without being prompted by the host. The cycle time can be programmed in milliseconds for values between 1 ms and 65536 ms.
Sync mode	After the sync telegram has been received by the host, the absolute encoder sends the current actual process value. If multiple nodes should respond to the sync telegram, the individual nodes report one after the other according to their CAN identifier. There is no programming of an offset time. The sync counter can be programmed so that the rotary encoder does not transmit until after a defined number of sync telegrams.

Programmable rotary encoder parameters

Parameter	Explanation
Operating parameter	The direction of rotation (complement) can be specified by parameter as the operating parameter. This parameter determines the direction of rotation in which the output code will ascend or descend.
Resolution per revolution	The "Resolution" parameter is used to program the rotary encoder so that a desired number of steps can be implemented in reference to one revolution.
Preset value	The preset value is the desired position value that must be achieved for a specific physical setting of the axis. The preset value parameter is used to set the actual position value to the desired actual process value.
Min. and max. limit switch	A total of two positions can be programmed. The absolute encoder sets one bit to high state in the 32 Bit actual process value if a value falls outside the range between these two positions.
Cam	8 freely programmable cams can be set within the overall resolution. This produces the functionality of a mechanical cam shifting mechanism.

Type Code

Release date: 2022-12-12 Date of issue: 2022-12-12 Filename: t183816_eng.pdf

Refer to "General Notes Relating to Pepperl+Fuchs Product Information".

- Adhere to the minimum bending radius as given in the data sheet and avoid tensile as well as shearing load.

Operating instructions

Every encoder manufactured by Pepperl+Fuchs leaves the factory in a perfect condition. In order to ensure this quality as well as a faultless operation, the following specifications have to be taken into consideration:

- Avoid any impact on the housing and in particular on the encoder shaft as well as the axial and radial overload of the encoder shaft.
- The accuracy and service life of the encoder is guaranteed only, if a suitable coupling is used.
- The operating voltage for the encoder and the follow-up device (e. g. control) has to be switched on and off simultaneously.
- Any wiring work has to be carried out with the system in a dead condition.
- The maximum operating voltages must not be exceeded. The devices have to be operated at extra-low safety voltage.

Notes on connecting the electric screening

The immunity to interference of a plant depends on the correct screening. In this field installation faults occur frequently. Often the screen is applied to one side only, and is then soldered to the earthing terminal with a wire, which is a valid procedure in LF engineering. However, in case of EMC the rules of HF engineering apply.

One basic goal in HF engineering is to pass the HF energy to earth at an impedance as low as possible as otherwise energy would discharge into the cable. A low impedance is achieved by a large-surface connection to metal surfaces.

The following instructions have to be observed:

- Apply the screen on both sides to a "common earth" in a large surface, if there is no risk of equipotential currents.
- The screen has to be passed behind the insulation and has to be clamped on a large surface below the tension relief.
- In case of cable connections to screw-type terminals, the tension relief has to be connected to an earthed surface.
- If plugs are used, metallised plugs only should be fitted (such as sub D plugs with metallised housing). Please observe the direct connection of the tension relief to the housing.

Advantage:	metallised connector,
shield	
	clamped with the strain
relief	clamp
Disadvantage:	soldering shield on



Safety instructions

Please observe the national safety and accident prevention regulations as well as the subsequent safety instructions in these operating instructions when working on encoders.

If failures cannot be remedied, the device has to be shut down and has to be secured against accidental operation.

Repairs may be carried out only by the manufacturer. Entry into and modifications of the device are not permissible.

Tighten the clamping ring only, if a shaft has been fitted in the area of the clamping ring (hollow shaft encoders).

Tighten all screws and plug connectors prior to operating the encoder.

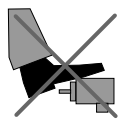

Do not stand on the encoder!

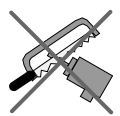

Do not remachine the drive shaft!

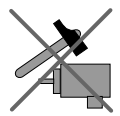

Avoid impact!



Do not remachine the housing!

Release date: 2022-12-12 Date of issue: 2022-12-12 Filename: t183816_eng.pdf