



Absolute rotary encoder ENA58TL-S***-IO-Link

- Absolute rotary encoder of the innovative Pure Line
- Solid shaft
- IO-Link Interface for process data, parameterization and diagnosis
- Suitable for condition monitoring
- Measuring range, direction of rotation and switching signals programmable
- Free of wear magnetic sampling
- High resolution and accuracy
- Status LEDs



Function

Absolute encoders with IO Link are high precision encoders with internal magnetic sampling. The integrated IO Link interface offers an optimal adaption to different applications through parameterization as well as process data transfer and condition monitoring.

Dimensions

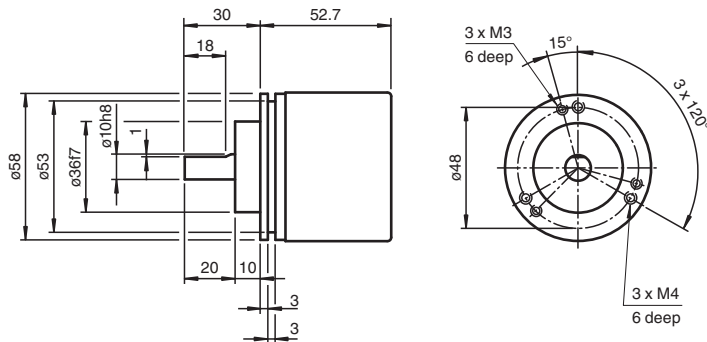

Clamping flange

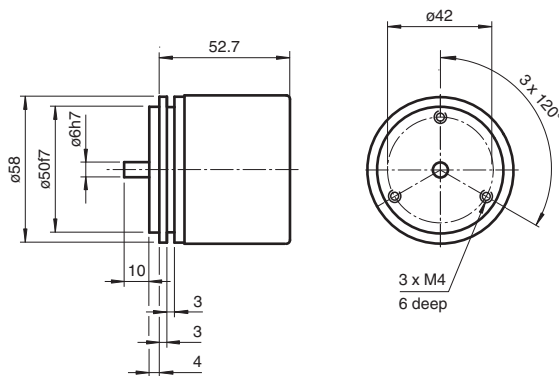

Servo flange

Release date: 2023-08-29 Date of issue: 2023-08-29 Filename: t193101_eng.pdf

Refer to "General Notes Relating to Pepperl+Fuchs Product Information".

Pepperl+Fuchs Group
www.pepperl-fuchs.com

USA: +1 330 486 0001
fa-info@us.pepperl-fuchs.com

Germany: +49 621 776 1111
fa-info@de.pepperl-fuchs.com

Singapore: +65 6779 9091
fa-info@sg.pepperl-fuchs.com

PEPPERL+FUCHS

Dimensions

Connections

Dimensions in mm

Connector M12

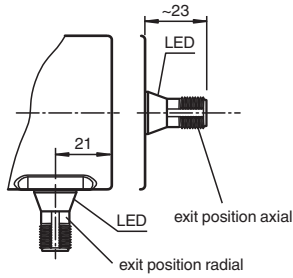

Technical Data

General specifications			
Detection type		magnetic sampling	
Device type		Absolute rotary encoder as Pure Line	
Measured variable		position Temperature	
Linearity error		≤ ± 0.1 °	
UL File Number		E223176 "For use in NFPA 79 Applications only" , if UL marking is marked on the product.	
Functional safety related parameters			
MTTF _d		566 a at 40 °C	
Mission Time (T _M)		20 a	
L ₁₀		420 E+8 revolutions at 40/110 N axial/radial shaft load	
Diagnostic Coverage (DC)		0 %	
Indicators/operating means			
LED STATUS		LED green flashing with short break (1 Hz) - IO-Link mode	
Electrical specifications			
Operating voltage	U _B	18 ... 30 V DC	
No-load supply current	I ₀	max. 50 mA	
Power consumption	P ₀	approx. 1.5 W	
Time delay before availability	t _v	< 1 s	
Interface			
Interface type		IO-Link	
IO-Link revision		1.1	
Device profile		Identification and Diagnosis - I&D	
Resolution			
Single turn		up to 16 Bit programmable	
Multiturn		up to 15 Bit programmable	
Overall resolution		up to 31 Bit programmable	
Process data		Input 12 Byte - measurement value 4 Byte - resolution 16 Bit - auxiliary measurement value 4 Byte - switching signals 2 Bit - diagnosis signals 2 Bit - status data	
Vendor ID		1 (0x0001)	
Device ID		5243907 (0x500403), 5243908 (0x500404), 5243911 (0x500407), 5243912 (0x500408)	
Transfer rate		COM3 (230.4 kbits/s)	

Release date: 2023-08-29 Date of issue: 2023-08-29 Filename: t193101_eng.pdf

Technical Data

Min. cycle time	1.5 ms
SIO mode support	no
Compatible master port type	Class A Class B (use 3-pole adapter or 3-wire cable)
Connection	
Connector	M12 connector, 5 pin , A-coded
Standard conformity	
Degree of protection	DIN EN 60529, IP65, IP67
Communication interface	IEC 61131-9 / IO-Link V1.1.2
Climatic testing	DIN EN 60068-2-78, no moisture condensation
Emitted interference	EN 61000-6-4:2007
Noise immunity	EN 61000-6-2:2005
Shock resistance	DIN EN 60068-2-27, 100 g, 6 ms
Vibration resistance	DIN EN 60068-2-6, 10 g, 10 ... 1000 Hz
Approvals and certificates	
UL approval	cULus Listed, General Purpose, Class 2 Power Source , if UL marking is marked on the product.
Ambient conditions	
Operating temperature	-40 ... 85 °C (-40 ... 185 °F)
Storage temperature	-40 ... 85 °C (-40 ... 185 °F)
Relative humidity	98 % , no moisture condensation
Mechanical specifications	
Material	
Housing	Zinc plated steel, painted
Flange	Aluminum
Shaft	Stainless steel
Mass	approx. 350 g
Rotational speed	max. 12000 min ⁻¹
Moment of inertia	< 30 gcm ²
Starting torque	< 3 Ncm
Shaft load	
Axial	40 N
Radial	110 N

Connection

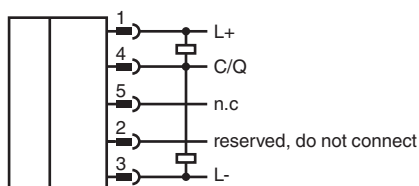

Connection Assignment

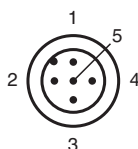

Release date: 2023-08-29 Date of issue: 2023-08-29 Filename: t193101_eng.pdf

Refer to "General Notes Relating to Pepperl+Fuchs Product Information".

Pepperl+Fuchs Group
www.pepperl-fuchs.com











USA: +1 330 486 0001
fa-info@us.pepperl-fuchs.com

Germany: +49 621 776 1111
fa-info@de.pepperl-fuchs.com

Singapore: +65 6779 9091
fa-info@sg.pepperl-fuchs.com

PF PEPPERL+FUCHS

Accessories









	ICE1-8IOL-G60L-V1D	Ethernet IO-Link module with 8 inputs/outputs
	V1-G-0,6M-PUR-V1-G	Cordset M12 socket straight to M12 plug straight A-coded, 4-pin, PUR cable grey
	V15-G-1M-PUR-V15-G	Cordset M12 socket straight to M12 plug straight A-coded, 5-pin, PUR cable grey
	9401 6*10	Spring steel coupling
	9401 6*6	Spring steel coupling
	9402 6*6	Spring steel coupling
	9404 6*6	Spring disk coupling
	9409 6*10	Bellows coupling
	9409 6*6	Bellows coupling
	9409 6*8	Bellows coupling
	9410 6*6	Precision coupling
	KW-6/10	Helical coupling
	KW-6/6	Helical coupling
	KW-6/8	Helical coupling
	9108, 6	Measuring wheel
	9109, 6	Measuring wheel for shaft diameter 6 mm
	9110, 6	Measuring wheel for shaft diameter 6 mm
	9113, 6	Measuring wheel for shaft diameter 6 mm
	MBT-36ALS	Spring-loaded mounting bracket with a diameter of 36 mm
	MBT-36ALS120	Spring arm for larger spring deflections for diameter 58 rotary encoder with clamping flange

Release date: 2023-08-29 Date of issue: 2023-08-29 Filename: t193101_eng.pdf

Refer to "General Notes Relating to Pepperl+Fuchs Product Information".

Pepperl+Fuchs Group
www.pepperl-fuchs.comUSA: +1 330 486 0001
fa-info@us.pepperl-fuchs.comGermany: +49 621 776 1111
fa-info@de.pepperl-fuchs.comSingapore: +65 6779 9091
fa-info@sg.pepperl-fuchs.com PEPPERL+FUCHS

Accessories

	ICE1-8IOL-G30L-V1D	Ethernet IO-Link module with 8 inputs/outputs
	ICE2-8IOL-G65L-V1D	EtherNet/IP IO-Link master with 8 inputs/outputs
	ICE3-8IOL-G65L-V1D	PROFINET IO IO-Link master with 8 inputs/outputs
	ICE2-8IOL-K45S-RJ45	EtherNet/IP IO-Link master with 8 inputs/outputs, DIN rail, screw terminal
	ICE3-8IOL-K45P-RJ45	PROFINET IO IO-Link master with 8 inputs/outputs, DIN rail, push-in terminals
	ICE3-8IOL-K45S-RJ45	PROFINET IO IO-Link master with 8 inputs/outputs, DIN rail, screw terminal
	IO-Link-Master02-USB	IO-Link master, supply via USB port or separate power supply, LED indicators, M12 plug for sensor connection
	ICE2-8IOL-K45P-RJ45	EtherNet/IP IO-Link master with 8 inputs/outputs, DIN rail, push-in connectors

Type Code

E N A 5 8 T L - S - - - - - 1 6 - I O - - - - 0 1

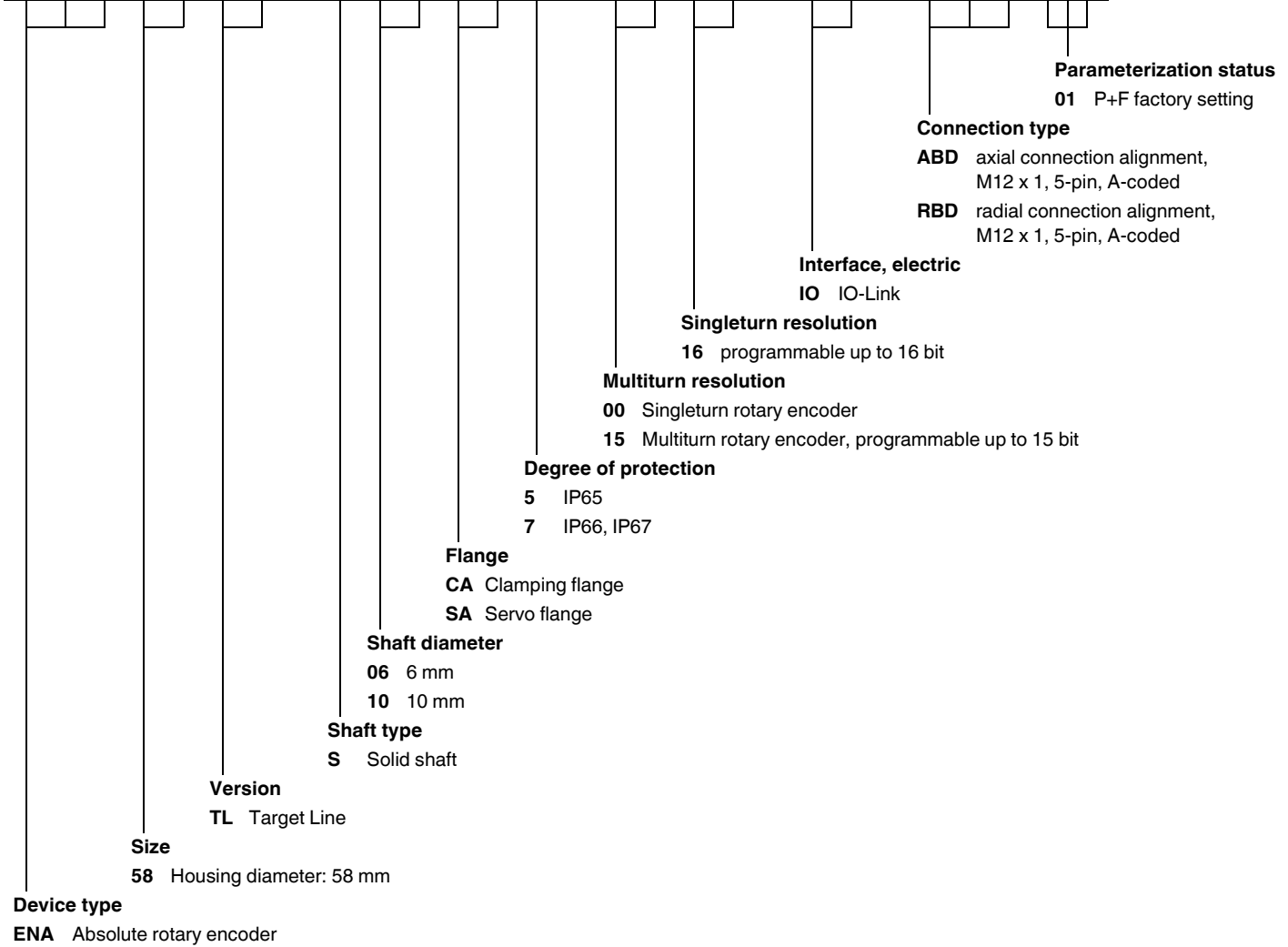

Release date: 2023-08-29 Date of issue: 2023-08-29 Filename: t193101_eng.pdf

Refer to "General Notes Relating to Pepperl+Fuchs Product Information".