

Multiturn absolute encoder

FVM58

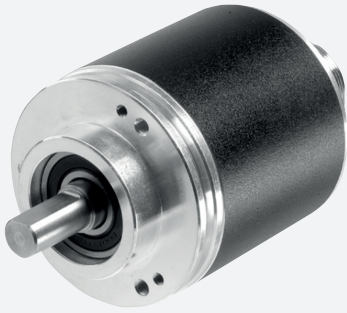

- Industrial standard housing $\varnothing 58$ mm
- 25-bit multiturn
- Output code: gray and binary
- Short-circuit proof push-pull output
- Inputs for selecting counting direction, LATCH, and PRESET
- Code change frequency up to 400 kHz
- Servo or clamping flange



Function

The emphasis for this series is on rapid data transfer. Position data are read directly out of the Gray code disc. The high code switching frequency of 400 kHz is achieved by consciously avoiding the use of a microcontroller. In terms of the mechanics, designs with clamping flange or servo flange are available for the FVM58 multiturn absolute encoder.

Dimensions

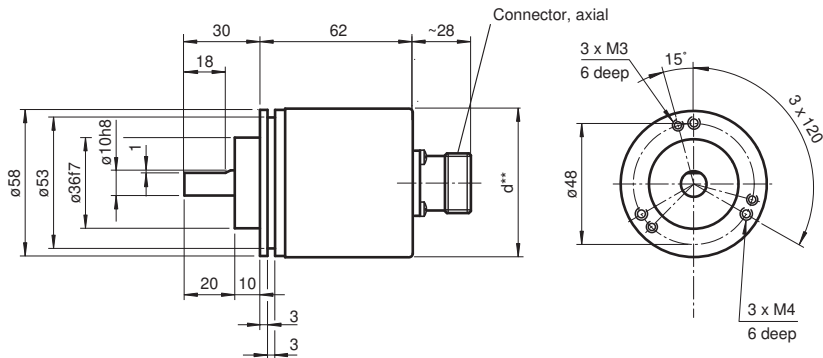

Clamping flange

** Aluminium: $d = 59$, stainless steel: $d = 61$

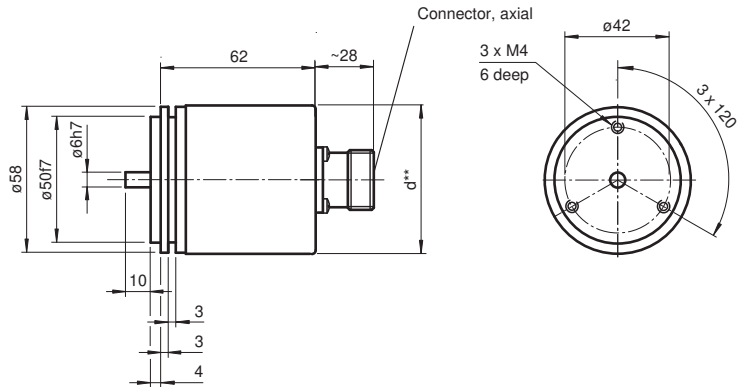

Servo flange

** Aluminium: $d = 59$, stainless steel: $d = 61$

Release date: 2023-02-14 Date of issue: 2023-02-14 Filename: t25462_eng.pdf

Refer to "General Notes Relating to Pepperl+Fuchs Product Information".

Pepperl+Fuchs Group
www.pepperl-fuchs.com

USA: +1 330 486 0001
fa-info@us.pepperl-fuchs.com

Germany: +49 621 776 1111
fa-info@de.pepperl-fuchs.com

Singapore: +65 6779 9091
fa-info@sg.pepperl-fuchs.com

Dimensions

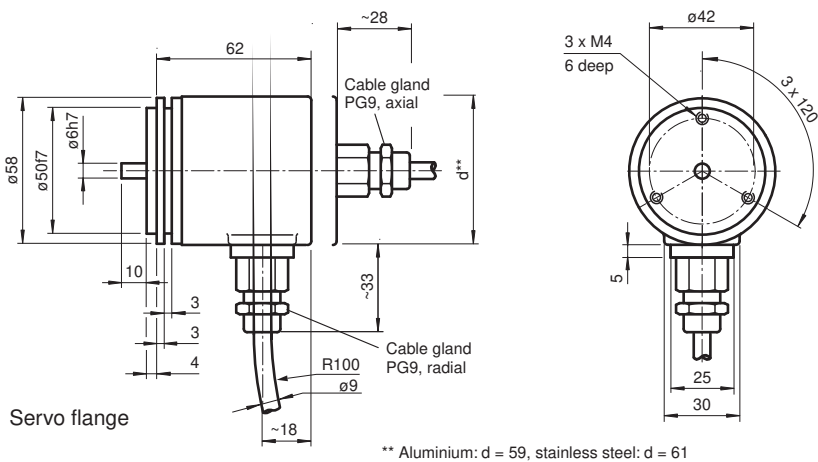
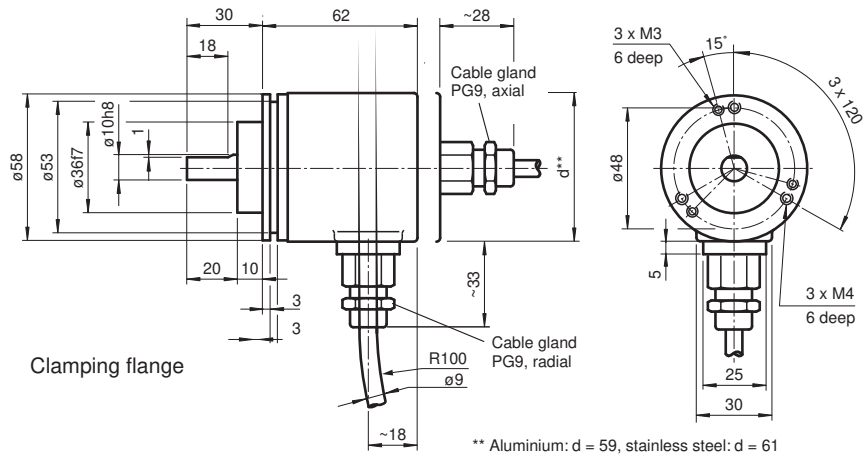

Technical Data

Electrical specifications

Operating voltage	U_B	10 ... 30 V DC
No-load supply current	I_0	max. 140 mA
Power consumption	P_0	≤ 2.5 W , without output drivers
Linearity		± 0.5 LSB
Output code		Gray code, binary code
Code course (counting direction)		cw ascending (clockwise rotation, code course ascending)
Code preparation time		0.3 ms

Interface

Interface type		Push-pull, parallel , short-circuit protected
Resolution		
Multiturn		25 Bit
Load current		20 mA
Voltage drop		≤ 2.5 V
Signal voltage		
High		operating voltage minus voltage drop
Low		≤ 2.8 V
Rise time		300 ns
De-energized delay		300 ns
Code change frequency		400 kHz

Input 1

Input type		Selection of counting direction (cw/ccw)
------------	--	--

Technical Data

Signal voltage		
High		10 ... 30 V
Low		0 ... 2 V
Input current		< 6 mA
Signal duration		min. 10 ms
Input 2		
Input type		Temporary storage (LATCH)
Signal voltage		
High		10 ... 30 V
Low		0 ... 2 V
Input current		< 6 mA
Signal duration		min. 100 µs
Switch-on delay		< 0.1 ms
Switch-off delay		< 0.1 ms
Input 3		
Input type		zero-set (PRESET)
Signal voltage		
High		10 ... 30 V
Low		0 ... 2 V
Input current		< 6 mA
Signal duration		min. 10 ms
Switch-on delay		< 1 ms
Connection		
Connector		type 9426, 26-pin
Cable		Ø9 mm, 15 x 2 x 0.14 mm ² , 2 m
Standard conformity		
Degree of protection		DIN EN 60529, IP65
Climatic testing		DIN EN 60068-2-3, no moisture condensation
Emitted interference		EN 61000-6-4:2007
Noise immunity		EN 61000-6-2:2005
Shock resistance		DIN EN 60068-2-27, 100 g, 6 ms
Vibration resistance		DIN EN 60068-2-6, 10 g, 10 ... 2000 Hz
Approvals and certificates		
UL approval		cULus Listed, General Purpose, Class 2 Power Source
Ambient conditions		
Operating temperature		-40 ... 85 °C (-40 ... 185 °F) cable models: -30 ... 70 °C (rigid wiring) -5 ... 70 °C (flexible wiring)
Storage temperature		-40 ... 85 °C (-40 ... 185 °F) (cable models: -5 ... 70 °C)
Mechanical specifications		
Material		
Combination 1		housing: powder coated aluminum flange: aluminum shaft: stainless steel
Combination 2 (Inox)		housing: stainless steel flange: stainless steel shaft: stainless steel
Mass		approx. 400 g (combination 1) approx. 800 g (combination 2)
Rotational speed		max. 12000 min ⁻¹
Moment of inertia		30 gcm ²
Starting torque		≤ 5 Ncm
Shaft load		
Axial		40 N
Radial		110 N





















Release date: 2023-02-14 Date of issue: 2023-02-14 Filename: t25462_eng.pdf

Refer to "General Notes Relating to Pepperl+Fuchs Product Information".

Pepperl+Fuchs Group
www.pepperl-fuchs.comUSA: +1 330 486 0001
fa-info@us.pepperl-fuchs.comGermany: +49 621 776 1111
fa-info@de.pepperl-fuchs.comSingapore: +65 6779 9091
fa-info@sg.pepperl-fuchs.com

PEPPERL+FUCHS

Accessories



	9203	Angled flange
	9426	Female cordset
	9310-3	Synchro clamping element
	9300	Mounting bracket for servo flange
	KW-10/10	Helical coupling
	KW-6/10	Helical coupling
	KW-6/6	Helical coupling
	KW-6/8	Helical coupling
	9401 10*10	Spring steel coupling
	9401 10*12	Spring steel coupling
	9401 6*10	Spring steel coupling
	9401 6*6	Spring steel coupling
	9402 6*6	Spring steel coupling
	9404 10*10	Spring disk coupling
	9404 6*6	Spring disk coupling
	9409 10*10	Bellows coupling
	9409 6*10	Bellows coupling
	9409 6*6	Bellows coupling
	9409 6*8	Bellows coupling
	9410 10*10	Precision coupling

Release date: 2023-02-14 Date of issue: 2023-02-14 Filename: t25462_eng.pdf

Refer to "General Notes Relating to Pepperl+Fuchs Product Information".

Pepperl+Fuchs Group
www.pepperl-fuchs.comUSA: +1 330 486 0001
fa-info@us.pepperl-fuchs.comGermany: +49 621 776 1111
fa-info@de.pepperl-fuchs.comSingapore: +65 6779 9091
fa-info@sg.pepperl-fuchs.com
 PEPPERL+FUCHS

Accessories

	9410 6*6	Precision coupling
	MBT-36ALS	Spring-loaded mounting bracket with a diameter of 36 mm

Connection

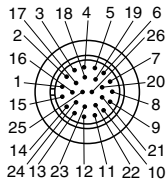
Signal	Cable Ø9 mm, 30-core	Connector 9426, 26-pin	Explanation
GND (rotary encoder)	White	1	Power supply
U _b (rotary encoder)	Brown	2	Power supply
Bit 1	Green	3	Data output
Bit 2	Yellow	4	Data output
Bit 3	Grey	5	Data output
Bit 4	Pink	6	Data output
Bit 5	Blue	7	Data output
Bit 6	Red	8	Data output
Bit 7	Black	9	Data output
Bit 8	Violet	10	Data output
Bit 9	Grey/Pink	11	Data output
Bit 10	Red/Blue	12	Data output
Bit 11	White/Green	13	Data output
Bit 12	Brown/Green	14	Data output
Bit 13	White/Yellow	15	Data output
Bit 14	Yellow/Brown	16	Data output
Bit 15	White/Grey	17	Data output
Bit 16	Grey/Brown	18	Data output
Bit 17	White/Pink	19	Data output
Bit 18	Pink/Brown	20	Data output
Bit 19	White/Blue	21	Data output
Bit 20	Brown/Blue	22	Data output
Bit 21	White/Red	23	Data output
Bit 22	Brown/Red	-	Data output
Bit 23	White/Black	-	Data output
Bit 24	Brown/Black	-	Data output
Bit 25	Pink/Green	-	Data output
V/R	Grey/Green	25	Input for selection of counting direction
Latch	Yellow/Grey	24	Temporary storage input
PRESET	Yellow/Pink	26	Zero setting
			

Interface

Inputs

Input for temporary storage (LATCH)
Input zero setting (PRESET)

Input level: "0" 0 V ... 2 V,
"1" 10 V ... 30 V,
I_e < 6 mA

Input for selection of counting direction (V/R)

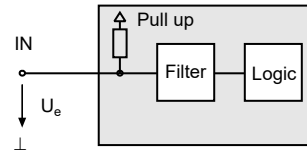
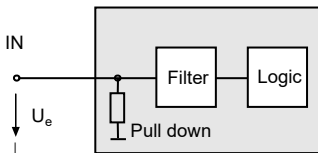

Input for selection of counting direction (V/R)

The counting direction for the absolute value rotary encoder as seen looking on the shaft is defined as right rotating (cw) rising or descending. The counting direction can be reversed with the V/R input. If the input is not used, the counting direction is defined as rising (standard), the level is at "1". Pulse duration T > 10 ms.

Input level: "1" or unused = rising code value with direction of rotation cw.

Input level: "0" = descending code value for direction of rotation cw.

Input for temporary storage (LATCH)

Release date: 2023-02-14 Date of issue: 2023-02-14 Filename: t25462_eng.pdf

Refer to "General Notes Relating to Pepperl+Fuchs Product Information".

With LATCH input "active", the position data on the parallel interface are "frozen". This makes it possible to accept position data without errors (especially for binary position data), since any change in the data during the read procedure is prevented. If this input is unused, its value is "0". Pulse duration $T > 100 \mu\text{s}$.

Input level: "1" = position data saved and stable at the output.

Input level: "0" or unused = position data free running at the output.

Input zero setting (PRESET)

By means of the PRESET input, the absolute value rotary encoder can be adjusted electronically to position value 0. Pulse duration $T > 10 \text{ ms}$.

Input level: "0" or unused = inactive.

Input level: "1" = Data output word is set to 0.

Type Code

Order code

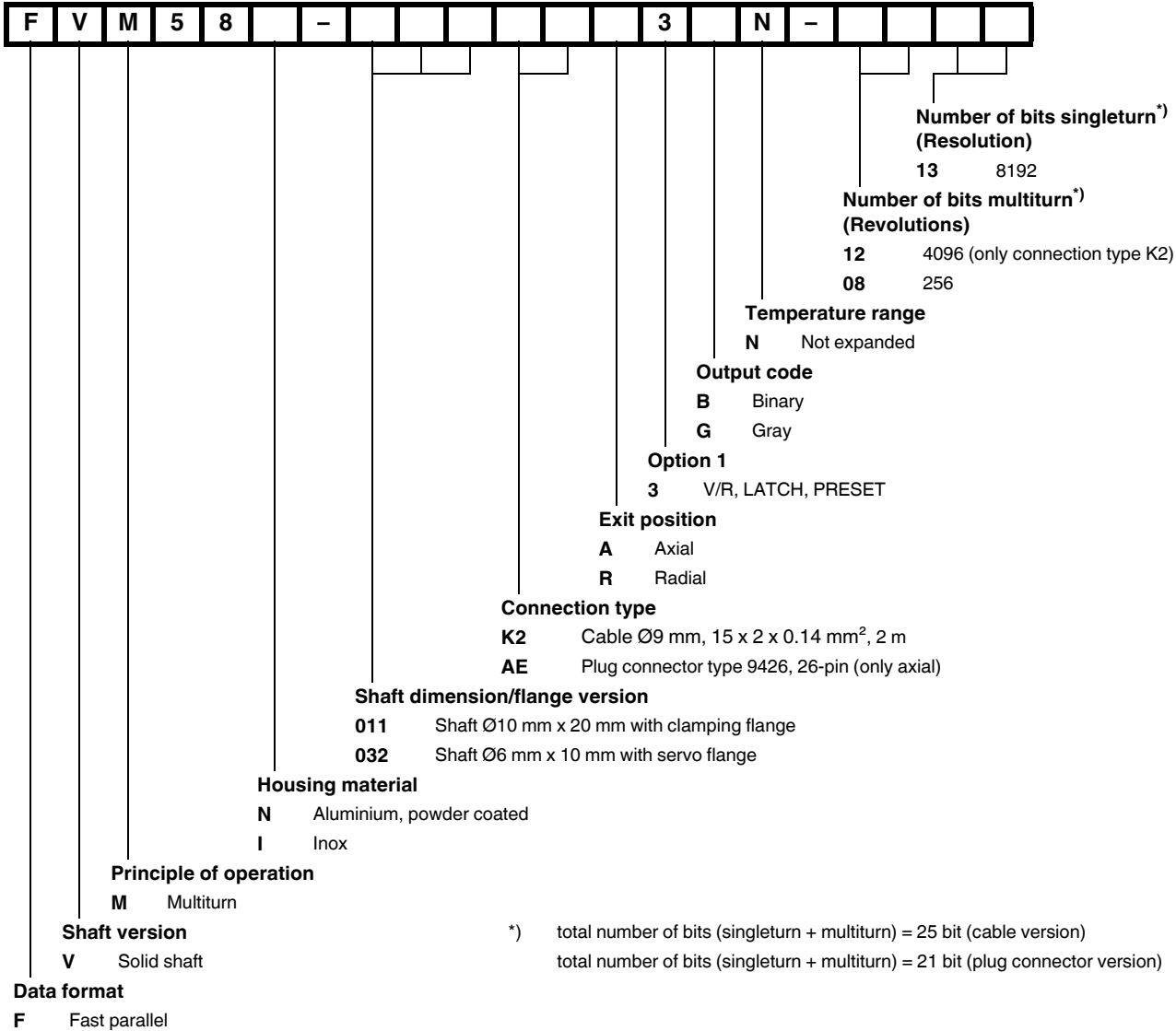

Release date: 2023-02-14 Date of issue: 2023-02-14 Filename: t25462_eng.pdf

Refer to "General Notes Relating to Pepperl+Fuchs Product Information".